



COCINA GAMA MEDIA L700/900/1100

roig
grupo



baron

Technical-Data



CR1350029 CR1350009 CR1200159 CR1015799 CR1017879 CR1350009
1940090 CR1017249 CR1016789 CR0980009 CR1017469
59 CR1016497 97347000 CR1017309 CR1017259 CR1018789 8031920170
1350029 CR1017879 CR1017309 CR1016559 CR1016619 BN9000413
9 CR1350069 CR0980009 MA92610000 CR1018399 CR1350069 CR1018399
1017259 CR1018399 CR1017569 CR1018789 CR1015869 CR1018399
0029 CR1018789 CR1017289 8031920170 CR1018399 8031920170
R1016709 CR1017879 CR1017469 CR1017309 CR1018789
89 CR1017249 CR1200159 CR1015799 CR1017879 97347000 CR1016949
6497 97347000 CR1016789 CR0980009 CR1017469 CR1017289
CR1017879 CR1017309 CR1017259 CR1018789 8031920170 CR1015929
0069 CR0980009 MA92610000 CR1016559 CR1016619 CR1200159 CR1016619 CR1016619
CR1015869 CR1018309 MA92610000 CR1018399 CR1018399
99 CR1017569 CR1018789 CR1350039 CR0988619 CR1018399
1018789 CR1017289 CR1015869 CR1018399 CR1017249
6709 CR1017879 CR1017469 CR1017309 CR1018789 CR1016619



baron

CODE-SOLUTION



Q70PCF/GE1006

TECHNICAL DATA

INDICE - INDEX - INHALT - TABLE DES MATIÈRES - TABLA DE CONTENIDO

Q70 PCF/GE1006	Q70 PC F/GE1006	Q70PC F /GE1006	Q70PCF/ GE 1006	Q70PCF/GE 10 06	Q70PCF/GE10 06
Serie / Series / Serie / Sèrie / Serie	Modello / Model / Modell / Modèle / Modelo		Versione / Version / Version / Version / versión	Modulo / Module / Modul / Moduler / Módulo	Configurazione
Q90 Q70 DI7 N1100 N550 6N	PC MA TP FT BM SP BRF PF	BR CP FR FRE GL G NE FO	E G IND WG VCE EE GE GG	2 4 6 8 10 12 16	XX XX XX XX XX XX

Serie / Series / Serie / Sèrie / Serie

Q90 Queen9	Q70 Queen7	DI7 Drop-In	N1100 / N550 Giano	6N 600
----------------------	----------------------	-----------------------	------------------------------	------------------

Modello / Model / Modell / Modèle / Modelo

PC Piano cottura Ranges Kochfeld Fourneaux Cocinas a	MA Talent Talent Talent Talent	TP Tuttapietra Solid top Glühplattenherde Plaque coup-de-feu Placa radiante	FR Friggitrici Deep fat fryers Friteusen Friteuses Freidoras	BRF / BF Brasiera fissa Multi cooking bratt pan Multi-Bräter Multi-Sauteuse Sarten Multiplo	BM / BG Bagnomaria Bain maries Wasserbäder Bain-marie Baño maria	SP Scalda patate Chip scuttle Warmhaltegerät Récipient chaud Recipiente caliente	PF Pentole Boiling pans Kochkessel Marmites Marmitas
CP Cuocipasta Pasta-cooker Nudelkocher Cuisièurs à pâte Cuecepastas	FT FryTop FryTop FryTop FryTop	BR Brasiere ribaltabili Tilting bratt pans Kippbratpfannen Sauteuses basculantes Sartenes basculantes	FREV Friggitrici EVO Deep fat fryers EVO Friteusen EVO Friteuses EVO Freidoras EVO	GL Griglie a pietra lavica Lava rock grills Lavasteingrills Grilles à pierre volcanique Barbacoa de piedra lávica	G Barbecue Barbecue Barbecue Barbecue	NE Elementi neutri Neutral units Neutralelemente Elements neutres Elementos neutros	FO Basi Forno Oven Bases Ofenbasen Bases de four Bases de horno

Base / Basis / Basis / Base / Base

- Top Top Top Top Top	F Su forno On oven Auf backöfen Sur fours En hornos	V Su vano On feet Auf Füßen Sur pieds En pief	VP Su vano Con porte On feet with doors Auf Füßen mit Türen Sur pieds vec des portes En pief con puertas
---	---	---	--

Versione / Version / Version / Version / versión /

E Elettrico Electric Elektrische Électrique Eléctrica	G Gas Gas Gas Gaz Gas	IND Induzione Induction Induktionsherde Induction Inducción	WG Wok a gas Wok gas Wok Gasherde Wok gas Wok gas	VCE / I Cucine elettriche in vetroceramica Electric ranges with ceramic glass Elektroherde Glaskeramik Plaque Électriques vitro ceramique Cocinas eléctricas vitroceramica	EE Elettrico Su forno Elettrico Electric On Electric oven Elektrisch auf elektrischem Ofen Électrique sur Four électrique Eléctrico en horno eléctrico	GE Gas Su forno Elettrico Gas On Electric oven Gas auf elektrischem Ofen Gaz sur Four électrique Gas en horno eléctrico
---	---	---	---	--	--	---

Modulo / Module / Modul / Moduler / Módulo

2 20cm	4 40cm	45 45cm	6 60cm	8 80cm	9 90cm	10 100cm	12 120cm	13 135cm	16 160cm
------------------	------------------	-------------------	------------------	------------------	------------------	--------------------	--------------------	--------------------	--------------------

Configurazione / Configuration / Konfiguration / Configuration / Configuración

■	PG.3	QUEEN9
■	PG.35	QUEEN7
■	PG.65	DROP-IN70
■	PG.73	SERIE GIANO
■	PG.93	SERIE 600

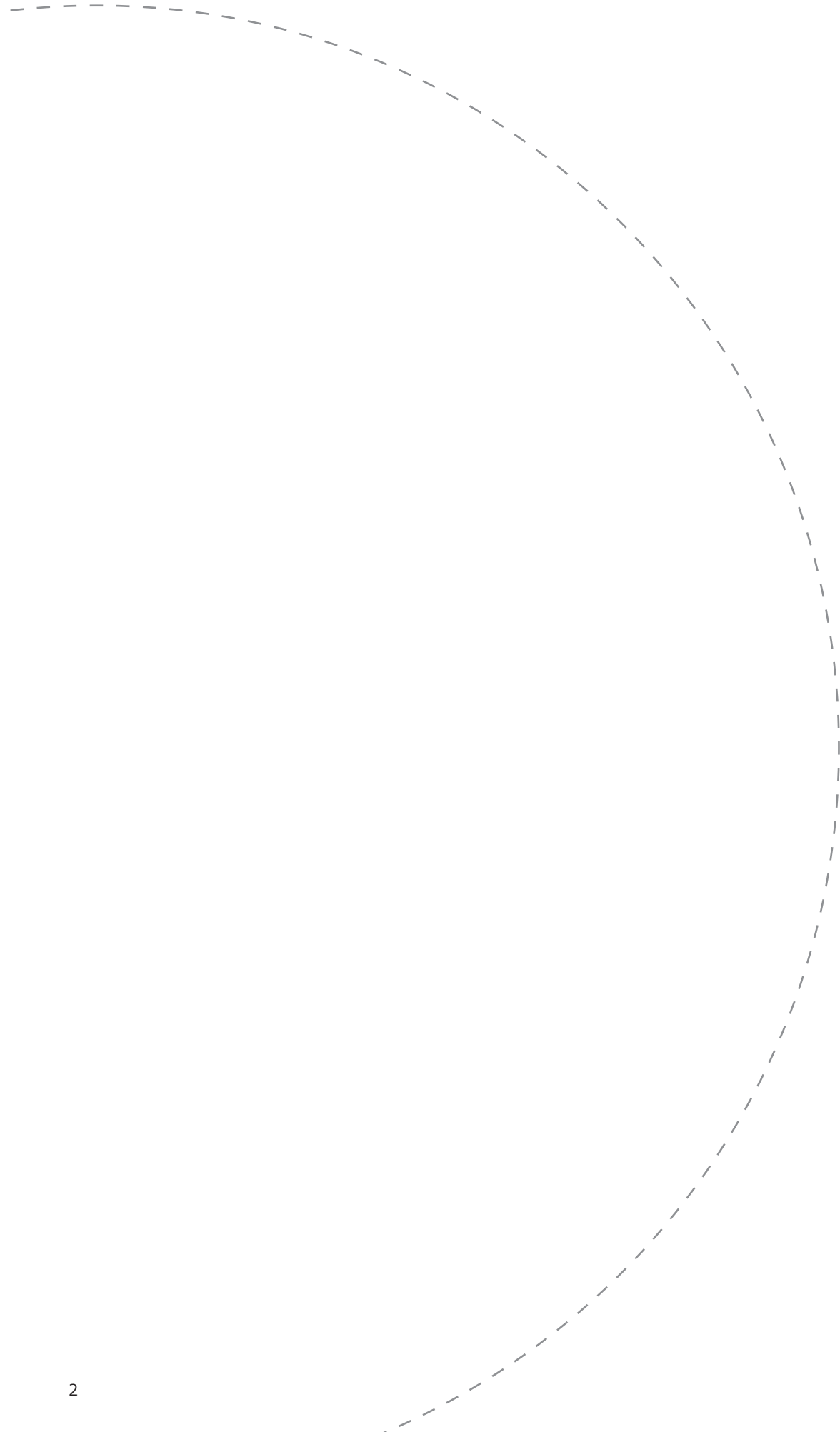











TECHNICAL DATA









Top



	Q90PC/G4001	Q90PC/G4011	Q90PC/G8001	Q90PC/G8011	Q90PC/G1201	Q90PC/G1211	Q90PC/G1601	Q90PC/G1611
	CR1015409	CR1015419	CR1015429	CR1015439	CR1015449	CR1015459	CR1015469	CR1015479
Dimensioni esterne External dimensions Außenabmessungen Dim. hors-tout Dimensiones exteriores	40x90x25	40x90x25	80x90x25	80x90x25	120x90x25	120x90x25	160x90x25	160x90x25
Bruciatori a gas (versione base) Gas burners (basic configuration) Gasbrenner (Grundausstattung) Brûleurs gaz (version de base) Quemadores a gas (versión normal)	kW 1 x 3,5 1 x 7	kW 1 x 3,5 1 x 7	kW 2 x 3,5 2 x 7	kW 2 x 3,5 2 x 7	kW 2 x 3,5 2 x 7 2x5,7	kW 2 x 3,5 2 x 7 2x5,7	kW 2 x 3,5 4 x 7 2x5,7	kW 2 x 3,5 4 x 7 2x5,7
Potenza totale gas Total gas power Gasgesamtleistung Puissance totale gaz Potencia total de gas	10.5kw Kcal9030 	10.5kw Kcal9030 	23.2kw Kcal19948 	23.2kw Kcal19948 	32.4kw Kcal27860 	32.4kw Kcal27860 	46,4kw Kcal 39897 	46,4kw Kcal 39897 
Sistema autopulente Water-bath system System selbstreinigend Système auto-nettoyant Sistema de autolimpiantes		●		●		●		●

Su vano
On cabinet
Auf unterbau
Sur placard
Sobre base neutra



	Q90PCV/G4001	Q90PCV/G4011	Q90PCV/G8001	Q90PCV/G8011	Q90PCV/G1201	Q90PCV/G1211	Q90PCV/G1601	Q90PCV/G1611
	CR1015489	CR1015509	CR1015529	CR1015549	CR1015569	CR1015589	CR1015609	CR1015629
Dimensioni esterne External dimensions Außenabmessungen Dim. hors-tout Dimensiones exteriores	40x90x87	40x90x87	80x90x87	80x90x87	120x90x87	120x90x87	160x90x87	160x90x87
Bruciatori a gas (versione base) Gas burners (basic configuration) Gasbrenner (Grundausstattung) Brûleurs gaz (version de base) Quemadores a gas (versión normal)	kW 1 x 3,5 1 x 7	kW 1 x 3,5 1 x 7	kW 2 x 3,5 2 x 7	kW 2 x 3,5 2 x 7	kW 2 x 3,5 2 x 7 2x5,7	kW 2 x 3,5 2 x 7 2x5,7	kW 2 x 3,5 4 x 7 2x5,7	kW 2 x 3,5 4 x 7 2x5,7
Potenza totale gas Total gas power Gasgesamtleistung Puissance totale gaz Potencia total de gas	10.5kw Kcal9030 	10.5kw Kcal9030 	23.2kw Kcal19948 	23.2kw Kcal19948 	32.4kw Kcal27860 	32.4kw Kcal27860 	46,4kw Kcal 39897 	46,4kw Kcal 39897 
Sistema autopulente Water-bath system System selbstreinigend Système auto-nettoyant Sistema de autolimpiantes		●		●		●		●

Su Forno/On oven/
Auf backöfen/Sur fours/
En hornos



IPX5	Q90PCF/G8001	Q90PCF/GE8001	Q90PCF/G8011	Q90PCF/GE8011	Q90PCFL/G1201
	CR1015649	CR1015659	CR1015669	CR1015679	CR1015729
Dimensioni esterne External dimensions Außenabmessungen Dim. hors-tout Dimensiones exteriores	80x90x87	40x90x87	80x90x87	80x90x87	120x90x87
Bruciatori a gas (versione base) Gas burners (basic configuration) Gasbrenner (Grundausrüstung) Brûleurs gaz (version de base) Queimadores a gas (versión normal)	1x 3,5 1x5,7 2 x 7	1x 3,5 1x5,7 2 x 7	1x 3,5 1x5,7 2 x 7	2 x 3,5 2 x 7	2 x 3,5 2 x 5,6 2 x 7
Sistema autopulente Water-bath system System selbstreinigend Système auto-nettoyant Sistema de autolimpiantes		●		●	
Dimensioni interne forni Oven internal dimensions Innenabm. der Backöfen Dim. int. des fours Dim. interiores hornos	53 x 70 x 30h Grid Dimens. (GN2/1)	53 x 70 x 30h Grid Dimens. (GN2/1)	53 x 70 x 30h Grid Dimens. (GN2/1)	53 x 70 x 30h Grid Dimens. (GN2/1)	93.7 x 69x 39h Grid Dimens. (95.4x65)
Potenza forni a gas Gas oven power Leistung der Gasbacköfen Puissance des fours à gaz Pot. de hornos a gas	8.5 kw		8.5 kw		9,5 kw
Potenza forni elettrici Electric oven power Leistung der E-Backöfen Puissance des fours électr. Pot. hornos eléc.		6 kW		6 kW	4,5kW
Potenza totale gas Total gas power Gesamtleistung Puissance totale gaz Potencia total de gas	31,7kw Kcal27257	23,2kw Kcal25107	31,7kw Kcal27257	23,2kw Kcal25107	41,9kw Kcal36027
Potenza totale elettrica Total electric power Elektrische Gesamtleistung Puissance totale électrique Potencia total eléctrica		6 kW		6 kW	4,5kW
Tensione alimentazione Supply voltage Ansch.-Spann. Tension d'alimentation Tensión de alimentación		400V - 3 N		400V - 3 N	400V - 3 N

Su Forno/On oven/
Auf backöfen/Sur fours/
En hornos



	Q90PCF/G1201	Q90PCF/GE1201	Q90PCF/G1211	Q90PCF/GE1211	Q90PCF/G1601	Q90PCF/GE1601	Q90PCF/G1611	Q90PCF/GE1611
	CR1015689	CR1015699	CR1015709	CR1015719	CR1015739	CR1015749	CR1015759	CR1015769
Dimensioni esterne External dimensions Außenabmessungen Dim. hors-tout Dimensiones exteriores	120x90x87 cm	120x90x87 cm	120x90x87 cm	120x90x87 cm	160x90x87 cm	160x90x87 cm	160x90x87 cm	160x90x87 cm
Bruciatori a gas (versione base) Gas burners (basic configuration) Gasbrenner (Grundausrüstung) Brûleurs gaz (version de base) Queimadores a gas (versión normal)	2x 3,5 2x5,7 2 x 7	2x 3,5 2x5,7 2 x 7	2x 3,5 2x5,7 2 x 7	2x 3,5 2x5,7 2 x 7	2x 3,5 2x5,7 4 x 7	2x 3,5 2x5,7 4 x 7	2x 3,5 2x5,7 4 x 7	2x 3,5 2x5,7 4 x 7
Sistema autopulente Water-bath system System selbstreinigend Système auto-nettoyant Sistema de autolimpiantes			●	●			●	●
Dimensioni interne forni Oven internal dimensions Innenabm. der Backöfen Dim. int. des fours Dim. interiores hornos	53 x 70 x 30h Grid Dimens. (GN2/1)	53 x 70 x 30h Grid Dimens. (GN2/1)	53 x 70 x 30h Grid Dimens. (GN2/1)	53 x 70 x 30h Grid Dimens. (GN2/1)	2 x 53 x 70 x 30h Grid Dimens. (GN2/1)	2 x 53 x 70 x 30h Grid Dimens. (GN2/1)	2 x 53 x 70 x 30h Grid Dimens. (GN2/1)	2 x 53 x 70 x 30h Grid Dimens. (GN2/1)
Potenza forni a gas Gas oven power Leistung der Gasbacköfen Puissance des fours à gaz Pot. de hornos a gas	8.5 kw		8.5 kw		2 x 8.5 kw		2 x 8.5 kw	
Potenza forni elettrici Electric oven power Leistung der E-Backöfen Puissance des fours électr. Pot. hornos eléc.		6 kW		6 kW		2x6kW		2x6kW
Potenza totale gas Total gas power Gesamtleistung Puissance totale gaz Potencia total de gas	40,9kw Kcal 35167	32,4kw Kcal 33018	40,9kw Kcal 35167	32,4kw Kcal 33018	63,4kw Kcal 54520	46,4kw Kcal 50215	63,4kw Kcal 54520	46,4kw Kcal 50215
Potenza totale elettrica Total electric power Elektrische Gesamtleistung Puissance totale électrique Potencia total eléctrica		6 kW		6 kW		12 kW		12 kW
Tensione alimentazione Supply voltage Ansch.-Spann. Tension d'alimentation Tensión de alimentación		400V - 3 N		400V - 3 N		400V - 3 N		400V - 3 N

		3,5 Kw	5,7 Kw	7 Kw	10 Kw
	V. Standard	1	-	1	-
	V. Potenziata	1	-	-	1
	V. Standard	1	1	2	-
	V. Potenziata	1	1	-	2
	V. Standard	2	2	2	-
	V. Potenziata	2	2	-	2
	V. Standard	2	2	4	-
	V. Potenziata	4	2	-	2

La disposizione dei bruciatori è libera, all'interno delle potenze certificate / Free position of burners conform to the certified power output / Die Anordnung der Brenner ist frei, innerhalb der zertifizierten Leistungen / La disposition des brûleurs est libre à l'intérieur des puissances certifiées / La distribución de los quemadores es libre dentro de las potencias certificadas

Contattare ufficio tecnico per fattibilità / Please contact sales department for availability / Für Anfragen wenden Sie sich an unsere Verkaufsabteilung / Adressez vous à notre service vente / Contactar nuestro despacho comercial



	Q90PCV/WG610 CR1015849	Q90PCV/WG614 CR1015869	Q90PCV/WG1020 CR1015889	Q90PCV/WG1028 CR1015909
Dimensioni esterne External dimensions Außenabmessungen Dim. hors-tout Dimensiones exteriores	cm 60 x 90 87 h	cm 60 x 90 87 h	cm 100 x 90 87 h	cm 100 x 90 87 h
Bruciatori a gas (versione base) Gas burners (basic configuration) Gasbrenner (Grundausstattung) Brûleurs gaz (version de base) Quemadores a gas (versión normal)	10kw	14kw	2x10kw	2x14kw
Potenza totale gas Total gas power Gesamtleistung Puissance totale gaz Potencia total de gas	10kw Kcal8600 	14kw Kcal12040 	20kw Kcal17200 	28kw Kcal24080

Talent / Talent/ Talent/ Talent/ Talent



IPX5	Q90MA/E400 CR1018559
Dimensioni esterne External dimensions Außenabmessungen Dim. hors-tout Dimensiones exteriores	cm 40 x 90 87 h
Dimensioni interne vasche / Tank internal dimensions Beckenin-nenabmessungen / Dimensions intérieures cuves Dim. interiores de las cubas	cm 30.5x58 h16.5
Materiale vasca Pan material / Beckenmaterial Matériau de la cuve / Material de la cuba	Duplex - (Inox)
Potenza totale elettrica Total electric power Elektrische Gesamtleistung Puissance totale électrique Potencia total eléctrica	5 Elements x 2kw kW 10
Capacità vasca Tank capacity Fassungsvermögen des Beckens Capacité de la cuve Capacidad de la cuba	l.17 - (GN1/1)
Tensione alimentazione Supply voltage Ansch.-Spann. Tension d'alimentation Tensión de alimentación	400V - 3 N



IPX5	Q90PC/E401	Q90PC/E801	Q90PCV/E401	Q90PCV/E801	Q90PCF/E801
	CR1015779	CR1015789	CR1015799	CR1015819	CR1015839
Dimensioni esterne External dimensions Außenabmessungen Dim. hors-tout Dimensiones exteriores	cm 40 x 90 25 h	cm 80x90 25h	cm 40x 90 87 h	cm 80x 90 87 h	cm 80x 90 87 h
Dimensioni interne forni Oven internal dimensions Innenabm. der Backöfen Dim. int. des fours Dim. interiores hornos					cm 53 x 70 x 30h Grid Dimens. (GN2/1)
Tipo di piastra Hot plate type Art der Kochplatte Type de plaque Tipo de placa	2 30x30cm	4 30x30cm	2 30x30cm	4 30x30cm	4 30x30cm
N° e potenza piastre Hot plate qty. and power Anz. u. Leistung d. Platten Nombre et puiss. des plaques N° y potencia de placas	kW 2 x 4	kW 4 x 4	kW 2 x 4	kW 4 x 4	kW 4 x 4
Potenza forni elettrici Electric oven power Leistung der Elektrobacköfen Puiss. des fours électriques Potencia hornos eléctricos					kW 6
Potenza totale elettrica Total electric power Elektrische Gesamtleistung Puissance totale électrique Potencia total eléctrica	kW 8 	kW 16 	kW 8 	kW 16 	kW 22
Tensione alimentazione Supply voltage Ansch.-Spann. Tension d'alimentation Tensión de alimentación	400V - 3 N	400V - 3 N	400V - 3 N	400V - 3 N	400V - 3 N



IPX5	Q90PC/VCE400	Q90PC/VCE800	Q90PCV/VCE400	Q90PCV/VCE800	Q90PCF/VCE800
	CR1015929	CR1015959	CR1015939	CR1015969	CR1015989
Dimensioni esterne External dimensions Außenabmessungen Dim. hors-tout Dimensiones exteriores	cm 40 x 90 25 h	cm 80x90 25h	cm 40x 90 87 h	cm 80x 90 87 h	cm 80x 90 87 h
Dimensioni interne forni Oven internal dimensions Innenabm. der Backöfen Dim. int. des fours Dim. interiores hornos					cm 53 x 70 x 30h Grid Dimens. (GN2/1)
Tipo di piastra Hot plate type Art der Kochplatte Type de plaque Tipo de placa	2 27x27cm	4 27x27cm	2 27x27cm	4 27x27cm	4 27x27cm
N° e potenza piastre Hot plate qty. and power Anz. u. Leistung d. Platten Nombre et puiss. des plaques N° y potencia de placas	kW 2 x 4	kW 4 x 4	kW 2 x 4	kW 4 x 4	kW 4 x 4
Potenza forni elettrici Electric oven power Leistung der Elektrobacköfen Puiss. des fours électriques Potencia hornos eléctricos					kW 6
Potenza totale elettrica Total electric power Elektrische Gesamtleistung Puissance totale électrique Potencia total eléctrica	kW 8 	kW 16 	kW 8 	kW 16 	kW 22
Tensione alimentazione Supply voltage Ansch.-Spann. Tension d'alimentation Tensión de alimentación	400V - 3 N	400V - 3 N	400V - 3 N	400V - 3 N	400V - 3 N



IPX5	Q90PC/IND400	Q90PCV/IND400	Q90PC/WOK400	Q90PCV/WOK400	Q90PC/IND800	Q90PCV/IND800
	CR1015999	CR1016009	CR1016059	CR1016069	CR1016029	CR1016039
Dimensioni esterne External dimensions Außenabmessungen Dim. hors-tout Dimensiones exteriores	cm 40 x 90 25 h	cm 40x90 87h	cm 40 x 90 25 h	cm 40x90 87h	cm 80x 90 25 h	cm 80x 90 87 h
Tipo di piastra Hot plate type Art der Kochplatte Type de plaque Tipo de placa	2 zone	2 zone	1 Ø30cm	1 Ø30cm	4 zone	4 zone
N° e potenza piastra Hot plate qty. and power Anz. u. Leistung d. Platten Nombre et puiss. des plaques Nº y potencia de placas	2 x 5 Kw	2 x 5 Kw	1 x 5 Kw	1 x 5 Kw	4 x 5 Kw	4 x 5 Kw
Potenza totale elettrica Total electric power Elektrische Gesamtleistung Puissance totale électrique Potencia total eléctrica	kW 10 	kW 10 	kW 5 	kW 5 	kW 20 	kW 20
Tensione alimentazione Supply voltage Ansch.-Spann. Tension d'alimentation Tensión de alimentación	400V - 3	400V - 3	400V - 3	400V - 3	400V - 3	400V - 3

Tuttapietra Elettrica / Solid top Electric / Elektroherde / Glühplattenherde / Plaque coup-de-feu Electriques/ Placa radiante elèctricas



IPX5	Q90TP/E800	Q90TPV/E800	Q90TPF/EE800
	CR1016099	CR1016179	CR1016319
Dimensioni esterne External dimensions Außenabmessungen Dim. hors-tout Dimensiones exteriores	cm 80 x 90 25h	cm 80 x 90 87 h	cm 80 x 90 87 h
Potenza resistenza Heating power Beheizungs element Puissance resistences Potencia resistencia	Kw 16	Kw 16	Kw 16
Potenza forno elettrico Electric oven power Leistung des Elektroherds Puissance du four électrique Potencia del horno eléctrico			kW 6
Potenza totale elettrica Total electric power Elektrische Gesamtleistung Puissance totale électrique Potencia total eléctrica	kW 16 	kW 16 	kW 22
Tensione alimentazione Supply voltage Ansch.-Spann. Tension d'alimentation Tensión de alimentación	400V - 3 N	400V - 3 N	400V - 3 N



Top	Q90TP/G800	Q90TP/G1201SX	Q90TP/G1201DX	Q90TPM/G8001SX	Q90TPM/G1201	Q90TP/G1601
	CR1016089	CR1016109	CR1016119	CR1016139	CR1016149	CR1016129
Dimensioni esterne External dimensions Außenabmessungen Dim. hors-tout Dimensiones exteriores	cm 80 x 90 25 h	cm 120 x 90 25 h	cm 120 x 90 25 h	cm 80 x 90 25 h	cm 120 x 90 25 h	cm 120 x 90 25 h
Potenza bruciatore piastra Solid top plate burner output Leistung des Plattenbrenners Puissance du brûleur de la plaque Potencia del quemador de la plancha	Kw 14	Kw 14	Kw 14	Kw 7	Kw 7	Kw 14
Potenza bruciatori aperti Open burner output Leistung der offenen Brenner Puissance des brûleurs des feux ouverts Potencia de los quemadores abiertos		kW 10,5	kW 10,5	kW 10,5	kW 10,5+10,5	kW 10,5+10,5
Potenza totale gas Total gas power Gasgesamtleistung Puissance totale gaz Potencia total de gas	14kw Kcal 12040 	24,5kw Kcal 21070 	24,5kw Kcal 21070 	17,5kw Kcal 15050 	28kw Kcal 24080 	35kw Kcal 30100

Tuttapietra / Solid top / Glühplattenherde / Plaque coup-de-feu / Placa radiante



Su vano On cabinet Auf unterbau Sur placard Sobre base neutra	Q90TPV/G800	Q90TPV/G1201SX	Q90TPV/G1201DX	Q90TPMV/G8001SX	Q90TPMV/G1201	Q90TPV/G1601
	CR1016159	CR1016199	CR1016219	CR1016259	CR1016279	CR1016239
Dimensioni esterne External dimensions Außenabmessungen Dim. hors-tout Dimensiones exteriores	cm 80 x 90 87 h	cm 120 x 90 87 h	cm 120 x 90 87 h	cm 80 x 90 87 h	cm 120 x 90 87 h	cm 120 x 90 87 h
Potenza bruciatore piastra Solid top plate burner output Leistung des Plattenbrenners Puissance du brûleur de la plaque Potencia del quemador de la plancha	Kw 14	Kw 14	Kw 14	Kw 7	Kw 7	Kw 14
Potenza bruciatori aperti Open burner output Leistung der offenen Brenner Puissance des brûleurs des feux ouverts Potencia de los quemadores abiertos		kW 10,5	kW 10,5	kW 10,5	kW 10,5+10,5	kW 10,5+10,5
Potenza totale gas Total gas power Gasgesamtleistung Puissance totale gaz Potencia total de gas	14kw Kcal 12040 	24,5kw Kcal 21070 	24,5kw Kcal 21070 	17,5kw Kcal 15050 	28kw Kcal 24080 	35kw Kcal 30100

Su Forno/On oven/
Auf backöfen/Sur fours/
En hornos



IPX5	Q90TPF/G800	Q90TPF/GE800	Q90TPMF/G8001SX	Q90TPMF/GE8001SX	Q90TP2F/G1601
	CR1016299	CR1016309	CR1016369	CR1016379	CR1016349
Dimensioni esterne External dimensions Außenabmessungen Dim. hors-tout Dimensiones exteriores	cm 80 x 90 87 h	cm 80 x 90 87 h	cm 80 x 90 87 h	cm 80 x 90 87 h	cm 160 x 90 87 h
Dimensioni interne forni Oven internal dimensions Innenabm. der Backöfen Dim. int. des fours Dim. interiores hornos	cm 53 x 70 x 30h Grid Dimens. (GN2/1)	cm 53 x 70 x 30h Grid Dimens. (GN2/1)	cm 53 x 70 x 30h Grid Dimens. (GN2/1)	cm 53 x 70 x 30h Grid Dimens. (GN2/1)	2x cm 53 x 70 x 30h Grid Dimens. (GN2/1)
Potenza bruciatore piastra Solid top plate burner output Leistung des Plattenbrenners Puissance du brûleur de la plaque Potencia del quemador de la plancha	Kw 14	Kw 14	Kw 7	Kw 7	Kw 14
Potenza bruciatori aperti Open burner output Leistung der offenen Brenner Puissance des brûleurs des feux ouverts Potencia de los quemadores abiertos			kW 10,5	kW 10,5	kW 10,5+10,5
Potenza forno gas Gas oven power Leistung des Gas-backofens Puissance du four à gaz Potencia del horno a gas	Kw 8,5		Kw 8,5		Kw 8,5+8,5
Potenza forno elettrico Electric oven power Leistung des Elektroherds Puissance du four électrique Potencia del horno eléctrico		kW 6		kW 6	
Potenza totale gas Total gas power Gesamtleistung Puissance totale gaz Potencia total de gas	22.5kw Kcal 12040 + 6880 	14kw Kcal 12037 	26kw Kcal 15050 + 6880 	17,5kw Kcal 15047 	52kw Kcal 30100 + 6880 + 6880
Potenza totale elettrica Total electric power Elektrische Gesamtleistung Puissance totale électrique Potencia total eléctrica		kW 6 		kW 6 	
Tensione alimentazione Supply voltage Ansch.-Spann. Tension d'alimentation Tensión de alimentación		400V - 3 N		400V - 3 N	

Su Forno/On oven/
Auf backöfen/Sur fours/
En hornos



IPX5	Q90TP2F/GE1601	Q90TPF/G1201SX	Q90TPF/GE1201SX	Q90TPMF/G1201	Q90TPMF/GE1201
	CR1016359	CR1016329	CR1016339	CR1016389	CR1016399
Dimensioni esterne External dimensions Außenabmessungen Dim. hors-tout Dimensiones exteriores	cm 160 x 90 87 h	cm 120x 90 87 h	cm 120x 90 87 h	cm 120x 90 87 h	cm 120x 90 87 h
Dimensioni interne forni Oven internal dimensions Innenabm. der Backöfen Dim. int. des fours Dim. interiores hornos	2x cm 53 x 70 x 30h Grid Dimens. (GN2/1)	cm 53 x 70 x 30h Grid Dimens. (GN2/1)	cm 53 x 70 x 30h Grid Dimens. (GN2/1)	cm 53 x 70 x 30h Grid Dimens. (GN2/1)	cm 53 x 70 x 30h Grid Dimens. (GN2/1)
Potenza bruciatore piastra Solid top plate burner output Leistung des Plattenbrenners Puissance du brûleur de la plaque Potencia del quemador de la plancha	Kw 14	Kw 14	Kw 14	Kw 7	Kw 7
Potenza bruciatori aperti Open burner output Leistung der offenen Brenner Puissance des brûleurs des feux ouverts Potencia de los quemadores abiertos	kW 10,5+10,5	kW 10,5	kW 10,5	kW 10,5+10,5	kW 10,5+10,5
Potenza forno gas Gas oven power Leistung des Gas-backofens Puissance du four à gaz Potencia del horno a gas		Kw 8,5		Kw 8,5	
Potenza forno elettrico Electric oven power Leistung des Elektroherds Puissance du four électrique Potencia del horno eléctrico	kW 6+6		kW 6		kW 6
Potenza totale gas Total gas power Gesamtleistung Puissance totale gaz Potencia total de gas	35kw Kcal 30100 	33kw Kcal 21070 + 6880 	24.5kw Kcal 21070 	36.5kw Kcal 24080 + 6880 	28kw Kcal 24080
Potenza totale elettrica Total electric power Elektrische Gesamtleistung Puissance totale électrique Potencia total eléctrica	kW 12 		kW 6 		kW 6
Tensione alimentazione Supply voltage Ansch.-Spann. Tension d'alimentation Tensión de alimentación	400V - 3 N		400V - 3 N		400V - 3 N

M 40
cm 40x90x25

	EXTRA UE									
	Q90FT/G403	Q90FTT/G403	Q90FTT/G405	Q90FT/G413	Q90FTT/G413	Q90FTT/G415	Q90FT/G400	Q90FTT/G400	Q90FT/G410	Q90FTT/G410
	CR1350009	CR1350019	CR1016429	CR1350029	CR1350039	CR1016459	CR1016409	CR1016419	CR1016439	CR1016449
Dim. esterne Ext. dimensions Außenabmessungen Dim. hors-tout Dimensiones exteriores	M 40	M 40	M 40	M 40	M 40	M 40	M 40	M 40	M 40	M 40
Dim. piastra Griddle plate dim. Plattenabmessungen Dim. de la plaque Dim. de la planch	cm 33,5 x 70	cm 33,5 x 70	cm 33,5 x 70	cm 33,5 x 70	cm 33,5 x 70	cm 33,5 x 70	cm 33,5 x 70	cm 33,5 x 70	cm 33,5 x 70	cm 33,5 x 70
Potenza gas Gas power Gasleistung Puissance gaz Potencia de gas	7kw Kcal6020	10.5kw Kcal9028	10.5kw Kcal6020	7kw Kcal6020	10.5kw Kcal9028	10.5kw Kcal6020	7kw Kcal6020	10.5kw Kcal9028	7kw Kcal6020	10.5kw Kcal9028

M 60
cm 60x90x25

	EXTRA UE									
	Q90FT/G603	Q90FTT/G603	Q90FTT/G605	Q90FT/G613	Q90FTT/G613	Q90FTT/G615	Q90FT/G623	Q90FTT/G623	Q90FTT/G625	
	CR1350049	CR1350059	CR1016489	CR1350069	CR1350079	CR1016519	CR1350089	CR1350099	CR1016549	
Dim. esterne Ext. dimensions Außenabmessungen Dim. hors-tout Dimensiones exteriores	M 60	M 60	M 60	M 60	M 60	M 60	M 60	M 60	M 60	
Dim. piastra Griddle plate dim. Plattenabmessungen Dim. de la plaque Dim. de la planch	cm 53,5 x 70	cm 53,5 x 70	cm 53,5 x 70	cm 53,5 x 70	cm 53,5 x 70	cm 53,5 x 70	cm 53,5 x 70	cm 53,5 x 70	cm 53,5 x 70	
Potenza gas Gas power Gasleistung Puissance gaz Potencia de gas	11kw Kcal 9460	14kw Kcal 12040	14kw Kcal 12040	11kw Kcal 9460	14kw Kcal 12040	14kw Kcal 12040	11kw Kcal 9460	14kw Kcal 12040	14kw Kcal 12040	

M 60
cm 60x90x25

	EXTRA UE					
	Q90FT/G600	Q90FTT/G600	Q90FT/G610	Q90FTT/G610	Q90FT/G620	Q90FTT/G620
	CR1016469	CR1016479	CR1016499	CR1016509	CR1016529	CR1016539
Dim. esterne Ext. dimensions Außenabmessungen Dim. hors-tout Dimensiones exteriores	M 60	M 60	M 60	M 60	M 60	M 60
Dim. piastra Griddle plate dim. Plattenabmessungen Dim. de la plaque Dim. de la planch	cm 53,5 x 70	cm 53,5 x 70	cm 53,5 x 70	cm 53,5 x 70	cm 53,5 x 70	cm 53,5 x 70
Potenza gas Gas power Gasleistung Puissance gaz Potencia de gas	11kw Kcal 9460	14kw Kcal 12040	11kw Kcal 9460	14kw Kcal 12040	11kw Kcal 9460	14kw Kcal 12040

M 80
cm 80x90x25

	EXTRA UE									
	Q90FT/G803	Q90FTT/G803	Q90FTT/G805	Q90FT/G813	Q90FTT/G813	Q90FTT/G815	Q90FT/G823	Q90FTT/G823	Q90FTT/G825	
	CR1350109	CR1350119	CR1016579	CR1350129	CR1350139	CR1016609	CR1350149	CR1350159	CR1016639	
Dim. esterne Ext. dimensions Außenabmessungen Dim. hors-tout Dimensiones exteriores	M 80	M 80	M 80	M 80	M 80	M 80	M 80	M 80	M 80	
Dim. piastra Griddle plate dim. Plattenabmessungen Dim. de la plaque Dim. de la planch	cm 73,5 x 70	cm 73,5 x 70	cm 73,5 x 70	cm 73,5 x 70	cm 73,5 x 70	cm 73,5 x 70	cm 73,5 x 70	cm 73,5 x 70	cm 73,5 x 70	
Potenza gas Gas power Gasleistung Puissance gaz Potencia de gas	14kw Kcal 12040	21kw Kcal18060	21kw Kcal18060	14kw Kcal 12040	21kw Kcal18060	21kw Kcal18060	14kw Kcal 12040	21kw Kcal18060	21kw Kcal18060	

M 80
cm 80x90x25

	EXTRA UE					
	Q90FT/G800	Q90FTT/G800	Q90FT/G810	Q90FTT/G810	Q90FT/G820	Q90FTT/G820
	CR1016559	CR1016569	CR1016589	CR1016599	CR1016619	CR1016629
Dim. esterne Ext. dimensions Außenabmessungen Dim. hors-tout Dimensiones exteriores	M 80	M 80	M 80	M 80	M 80	M 80
Dim. piastra Griddle plate dim. Plattenabmessungen Dim. de la plaque Dim. de la planch	cm 73,5 x 70	cm 73,5 x 70	cm 73,5 x 70	cm 73,5 x 70	cm 73,5 x 70	cm 73,5 x 70
Potenza gas Gas power Gasleistung Puissance gaz Potencia de gas	14kw Kcal 12040	21kw Kcal18060	14kw Kcal 12040	21kw Kcal18060	14kw Kcal 12040	21kw Kcal18060

M 120
cm 120x90x25

	EXTRA UE					
	Q90FTT/G1203	Q90FTT/G1205	Q90FTT/G1223	Q90FTT/G1225	Q90FTT/G1200	Q90FTT/G1220
	CR1350169	CR1016659	CR1350179	CR1016679	CR1016649	CR1016669
Dim. esterne Ext. dimensions Außenabmessungen Dim. hors-tout Dimensiones exteriores	M 120	M 120	M 120	M 120	M 120	M 120
Dim. piastra Griddle plate dim. Plattenabmessungen Dim. de la plaque Dim. de la planch	cm 113,5 x 70	cm 113,5 x 70	cm 113,5 x 70	cm 113,5 x 70	cm 113,5 x 70	cm 113,5 x 70
Potenza gas Gas power Gasleistung Puissance gaz Potencia de gas	31,5kw Kcal 27090	31,5kw Kcal 27090	31,5kw Kcal 27090	31,5kw Kcal 27090	31,5kw Kcal 27090	31,5kw Kcal 27090

M 40
cm 40x90x87

	EXTRA UE						EXTRA UE			
	Q90FTV/G403	Q90FTTV/G403	Q90FTTV/G405	Q90FTV/G413	Q90FTTV/G413	Q90FTTV/G415	Q90FTV/G400	Q90FTTV/G400	Q90FTV/G410	Q90FTTV/G410
	CR1350189	CR1350209	CR1016729	CR1350229	CR1350249	CR1016789	CR1016689	CR1016709	CR1016749	CR1016769
Dim. esterne Ext. dimensions Außenabmessungen Dim. hors-tout Dimensiones exteriores	M 40	M 40	M 40	M 40	M 40	M 40	M 40	M 40	M 40	M 40
Dim. piastra Griddle plate dim. Plattenabmessungen Dim. de la plaque Dim. de la planch	cm 53,5 x 70	cm 53,5 x 70	cm 53,5 x 70	cm 53,5 x 70	cm 53,5 x 70	cm 53,5 x 70	cm 53,5 x 70	cm 53,5 x 70	cm 53,5 x 70	cm 53,5 x 70
Potenza gas Gas power Gasleistung Puisance gaz Potencia de gas	7kw Kcal6020	10.5kw Kcal9028	10.5kw Kcal6020	7kw Kcal6020	10.5kw Kcal9028	10.5kw Kcal6020	7kw Kcal6020	10.5kw Kcal9028	7kw Kcal6020	10.5kw Kcal9028

M 60
cm 60x90x87

	Q90FTV/G603	Q90FTTV/G603	Q90FTTV/G605	Q90FTV/G613	Q90FTTV/G613	Q90FTTV/G615	Q90FTV/G623	Q90FTTV/G623	Q90FTTV/G625
	CR1350269	CR1350289	CR1016849	CR1350309	CR1350329	CR1016909	CR1350349	CR1350369	CR1016969
Dim. esterne Ext. dimensions Außenabmessungen Dim. hors-tout Dimensiones exteriores	M 60	M 60	M 60	M 60	M 60	M 60	M 60	M 60	M 60
Dim. piastra Griddle plate dim. Plattenabmessungen Dim. de la plaque Dim. de la planch	cm 53,5 x 70	cm 53,5 x 70	cm 53,5 x 70	cm 53,5 x 70	cm 53,5 x 70	cm 53,5 x 70	cm 53,5 x 70	cm 53,5 x 70	cm 53,5 x 70
Potenza gas Gas power Gasleistung Puisance gaz Potencia de gas	11kw Kcal 9460	14kw Kcal 12040	14kw Kcal 12040	11kw Kcal 9460	14kw Kcal 12040	14kw Kcal 12040	11kw Kcal 9460	14kw Kcal 12040	14kw Kcal 12040

M 60
cm 60x90x87

	EXTRA UE					
	Q90FT/G600	Q90FTT/G600	Q90FT/G610	Q90FTT/G610	Q90FT/G620	Q90FTT/G620
	CR1016469	CR1016479	CR1016499	CR1016509	CR1016529	CR1016539
Dim. esterne Ext. dimensions Außenabmessungen Dim. hors-tout Dimensiones exteriores	M 60	M 60	M 60	M 60	M 60	M 60
Dim. piastra Griddle plate dim. Plattenabmessungen Dim. de la plaque Dim. de la planch	cm 53,5 x 70	cm 53,5 x 70	cm 53,5 x 70	cm 53,5 x 70	cm 53,5 x 70	cm 53,5 x 70
Potenza gas Gas power Gasleistung Puisance gaz Potencia de gas	11kw Kcal 9460	14kw Kcal 12040	11kw Kcal 9460	14kw Kcal 12040	11kw Kcal 9460	14kw Kcal 12040

M 80
cm 80x90x87

	Q90FTV/G803	Q90FTTV/G803	Q90FTTV/G805	Q90FTV/G813	Q90FTTV/G813	Q90FTTV/G815	Q90FTV/G823	Q90FTTV/G823	Q90FTTV/G825
	CR1350389	CR1350409	CR1017029	CR1350429	CR1350449	CR1017089	CR1350469	CR1350489	CR1017149
Dim. esterne Ext. dimensions Außenabmessungen Dim. hors-tout Dimensiones exteriores	M 80	M 80	M 80	M 80	M 80	M 80	M 80	M 80	M 80
Dim. piastra Griddle plate dim. Plattenabmessungen Dim. de la plaque Dim. de la planch	cm 73,5 x 70	cm 73,5 x 70	cm 73,5 x 70	cm 73,5 x 70	cm 73,5 x 70	cm 73,5 x 70	cm 73,5 x 70	cm 73,5 x 70	cm 73,5 x 70
Potenza gas Gas power Gasleistung Puisance gaz Potencia de gas	14kw Kcal 12040	21kw Kcal 18060	21kw Kcal 18060	14kw Kcal 12040	21kw Kcal 18060	21kw Kcal 18060	14kw Kcal 12040	21kw Kcal 18060	21kw Kcal 18060

M 80
cm 80x90x87

	EXTRA UE					
	Q90FTV/G800	Q90FTTV/G800	Q90FTV/G810	Q90FTTV/G810	Q90FTV/G820	Q90FTTV/G820
	CR1016989	CR1017009	CR1017049	CR1017069	CR1017109	CR1017129
Dim. esterne Ext. dimensions Außenabmessungen Dim. hors-tout Dimensiones exteriores	M 80	M 80	M 80	M 80	M 80	M 80
Dim. piastra Griddle plate dim. Plattenabmessungen Dim. de la plaque Dim. de la planch	cm 73,5 x 70	cm 73,5 x 70	cm 73,5 x 70	cm 73,5 x 70	cm 73,5 x 70	cm 73,5 x 70
Potenza gas Gas power Gasleistung Puisance gaz Potencia de gas	14kw Kcal 12040	21kw Kcal 18060	14kw Kcal 12040	21kw Kcal 18060	14kw Kcal 12040	21kw Kcal 18060

M120
cm 120x90x87

	EXTRA UE					
	Q90FTTV/G1203	Q90FTTV/G1205	Q90FTTV/G1223	Q90FTTV/G1225	Q90FTTV/G1200	Q90FTTV/G1220
	CR1350509	CR1017189	CR1350529	CR1017229	CR1017169	CR1017209
Dim. esterne Ext. dimensions Außenabmessungen Dim. hors-tout Dimensiones exteriores	M 120	M 120	M 120	M 120	M 120	M 120
Dim. piastra Griddle plate dim. Plattenabmessungen Dim. de la plaque Dim. de la planch	cm 113,5 x 70	cm 113,5 x 70	cm 113,5 x 70	cm 113,5 x 70	cm 113,5 x 70	cm 113,5 x 70
Potenza gas Gas power Gasleistung Puisance gaz Potencia de gas	31,5kw Kcal 27090	31,5kw Kcal 27090	31,5kw Kcal 27090	31,5kw Kcal 27090	31,5kw Kcal 27090	31,5kw Kcal 27090

M 40
cm 40x90x25



IPX5	EXTRA UE					
	Q90FT/E403	Q90FT/E405	Q90FT/E413	Q90FT/E415	Q90FT/E400	Q90FT/E410
	CR1350549	CR1017259	CR1350559	CR1017279	CR1017249	CR1017269
Dim. esterne Ext. dimensions Außenabmessungen Dim. hors-tout Dimensiones exteriores	M 40	M 40	M 40	M 40	M 40	M 40
Dim. piastra Griddle plate dim. Plattenabmessungen Dim. de la plaque Dim. de la planch	cm 33,5 x 53	cm 33,5 x 53	cm 33,5 x 53	cm 33,5 x 53	cm 33,5 x 53	cm 33,5 x 53
Potenza elettrica electric power Elektrische Gesamtleistung Puissance électrique Potencia eléctrica	kW 7.5 Ac Ac400V-3N ⚡	kW 7.5 Ac Ac400V-3N ⚡	kW 7.5 Ac Ac400V-3N ⚡	kW 7.5 Ac Ac400V-3N ⚡	kW 7.5 Ac Ac400V-3N ⚡	kW 7.5 Ac Ac400V-3N ⚡

M 60
cm 60x90x25



IPX5	EXTRA UE					
	Q90FT/E603	Q90FT/E605	Q90FT/G613	Q90FT/E615	Q90FT/G623	Q90FT/E625
	CR1350569	CR1017299	CR1350069	CR1017319	CR1350089	CR1017339
Dim. esterne Ext. dimensions Außenabmessungen Dim. hors-tout Dimensiones exteriores	M 60	M 60	M 60	M 60	M 60	M 60
Dim. piastra Griddle plate dim. Plattenabmessungen Dim. de la plaque Dim. de la planch	cm 53,5 x 53	cm 53,5 x 53	cm 53,5 x 53	cm 53,5 x 53	cm 53,5 x 53	cm 53,5 x 53
Potenza elettrica electric power Elektrische Gesamtleistung Puissance électrique Potencia eléctrica	kW 10.5 Ac400V-3N ⚡	kW 10.5 Ac400V-3N ⚡	kW 10.5 Ac400V-3N ⚡	kW 10.5 Ac400V-3N ⚡	kW 10.5 Ac400V-3N ⚡	kW 10.5 Ac400V-3N ⚡

M 60
cm 60x90x25



IPX5	EXTRA UE		
	Q90FT/E600	Q90FT/E610	Q90FT/E620
	CR1017289	CR1017309	CR1017329
Dim. esterne Ext. dimensions Außenabmessungen Dim. hors-tout Dimensiones exteriores	M 60	M 60	M 60
Dim. piastra Griddle plate dim. Plattenabmessungen Dim. de la plaque Dim. de la planch	cm 53,5 x 53	cm 53,5 x 53	cm 53,5 x 53
Potenza elettrica electric power Elektrische Gesamtleistung Puissance électrique Potencia eléctrica	kW 10.5 Ac400V-3N ⚡	kW 10.5 Ac400V-3N ⚡	kW 10.5 Ac400V-3N ⚡

M 80
cm 80x90x25



IPX5	EXTRA UE					
	Q90FT/E803	Q90FT/E805	Q90FT/E813	Q90FT/E815	Q90FT/E823	Q90FT/E825
	CR1350599	CR1017359	CR1350609	CR1017379	CR1350619	CR1017399
Dim. esterne Ext. dimensions Außenabmessungen Dim. hors-tout Dimensiones exteriores	M80	M80	M80	M80	M80	M80
Dim. piastra Griddle plate dim. Plattenabmessungen Dim. de la plaque Dim. de la planch	cm 73,5 x 53	cm 73,5 x 53	cm 73,5 x 53	cm 73,5 x 53	cm 73,5 x 53	cm 73,5 x 53
Potenza elettrica electric power Elektrische Gesamtleistung Puissance électrique Potencia eléctrica	kW 15 Ac400V-3N ⚡	kW 15 Ac400V-3N ⚡	kW 15 Ac400V-3N ⚡	kW 15 Ac400V-3N ⚡	kW 15 Ac400V-3N ⚡	kW 15 Ac400V-3N ⚡

M 80
cm 80x90x25



IPX5	EXTRA UE		
	Q90FT/E800	Q90FT/E810	Q90FT/E820
	CR1017349	CR1017369	CR1017389
Dim. esterne Ext. dimensions Außenabmessungen Dim. hors-tout Dimensiones exteriores	M80	M80	M80
Dim. piastra Griddle plate dim. Plattenabmessungen Dim. de la plaque Dim. de la planch	cm 73,5 x 53	cm 73,5 x 53	cm 73,5 x 53
Potenza elettrica electric power Elektrische Gesamtleistung Puissance électrique Potencia eléctrica	kW 15 Ac400V-3N ⚡	kW 15 Ac400V-3N ⚡	kW 15 Ac400V-3N ⚡

M 120
cm 120x90x25



IPX5	EXTRA UE					
	Q90FT/E1203	Q90FT/E1205	Q90FT/E1223	Q90FT/E1225	Q90FT/E1200	Q90FT/E1220
	CR1350629	CR1017419	CR1350639	CR1017439	CR1017409	CR1017429
Dim. esterne Ext. dimensions Außenabmessungen Dim. hors-tout Dimensiones exteriores	M120	M120	M120	M120	M120	M120
Dim. piastra Griddle plate dim. Plattenabmessungen Dim. de la plaque Dim. de la planch	cm 113,5 x 53	cm 113,5 x 53	cm 113,5 x 53	cm 113,5 x 53	cm 113,5 x 53	cm 113,5 x 53
Potenza elettrica electric power Elektrische Gesamtleistung Puissance électrique Potencia eléctrica	kW 22.5 Ac400V-3N ⚡	kW 22.5 Ac400V-3N ⚡	kW 22.5 Ac400V-3N ⚡	kW 22.5 Ac400V-3N ⚡	kW 22.5 Ac400V-3N ⚡	kW 22.5 Ac400V-3N ⚡

M 40
cm 40x90x87



IPX5	EXTRA UE					
	Q90FTV/E403	Q90FTV/E405	Q90FTV/E413	Q90FTV/E415	Q90FTV/E400	Q90FTV/E410
	CR1350649	CR1017469	CR1350669	CR1017509	CR1017449	CR1017489
Dim. esterne Ext. dimensions Außenabmessungen Dim. hors-tout Dimensiones exteriores	M 40	M 40	M 40	M 40	M 40	M 40
Dim. piastra Griddle plate dim. Plattenabmessungen Dim. de la plaque Dim. de la planch	cm 33,5 x 53	cm 33,5 x 53	cm 33,5 x 53	cm 33,5 x 53	cm 33,5 x 53	cm 33,5 x 53
Potenza elettrica electric power Elektrische Gesamtleistung Puissance électrique Potencia eléctrica	kW 7.5 Ac Ac400V-3N ⚡	kW 7.5 Ac Ac400V-3N ⚡	kW 7.5 Ac Ac400V-3N ⚡	kW 7.5 Ac Ac400V-3N ⚡	kW 7.5 Ac Ac400V-3N ⚡	kW 7.5 Ac Ac400V-3N ⚡

M 60
cm 60x90x87



IPX5	EXTRA UE					
	Q90FTV/E603	Q90FTV/E605	Q90FTV/E613	Q90FTV/E615	Q90FTV/E623	Q90FTV/E625
	CR1350689	CR1017549	CR1350709	CR1017589	CR1350729	CR1017629
Dim. esterne Ext. dimensions Außenabmessungen Dim. hors-tout Dimensiones exteriores	M 60	M 60	M 60	M 60	M 60	M 60
Dim. piastra Griddle plate dim. Plattenabmessungen Dim. de la plaque Dim. de la planch	cm 53,5 x 53	cm 53,5 x 53	cm 53,5 x 53	cm 53,5 x 53	cm 53,5 x 53	cm 53,5 x 53
Potenza elettrica electric power Elektrische Gesamtleistung Puissance électrique Potencia eléctrica	kW 10.5 Ac400V-3N ⚡	kW 10.5 Ac400V-3N ⚡	kW 10.5 Ac400V-3N ⚡	kW 10.5 Ac400V-3N ⚡	kW 10.5 Ac400V-3N ⚡	kW 10.5 Ac400V-3N ⚡

M 60
cm 60x90x87



IPX5	EXTRA UE		
	Q90FTV/E600	Q90FTV/E610	Q90FTV/E620
	CR1017529	CR1017569	CR1017609
Dim. esterne Ext. dimensions Außenabmessungen Dim. hors-tout Dimensiones exteriores	M 60 FE	M 60 FE	M 60 FE
Dim. piastra Griddle plate dim. Plattenabmessungen Dim. de la plaque Dim. de la planch	cm 53,5 x 53	cm 53,5 x 53	cm 53,5 x 53
Potenza elettrica electric power Elektrische Gesamtleistung Puissance électrique Potencia eléctrica	kW 10.5 Ac400V-3N ⚡	kW 10.5 Ac400V-3N ⚡	kW 10.5 Ac400V-3N ⚡

M 80
cm 80x90x87



IPX5	EXTRA UE					
	Q90FTV/E803	Q90FTV/E805	Q90FTV/E813	Q90FTV/E815	Q90FTV/E823	Q90FTV/E825
	CR1350749	CR1017669	CR1350769	CR1017709	CR1350789	CR1017749
Dim. esterne Ext. dimensions Außenabmessungen Dim. hors-tout Dimensiones exteriores	M 80	M 80	M 80	M 80	M 80	M 80
Dim. piastra Griddle plate dim. Plattenabmessungen Dim. de la plaque Dim. de la planch	cm 73,5 x 53	cm 73,5 x 53	cm 73,5 x 53	cm 73,5 x 53	cm 73,5 x 53	cm 73,5 x 53
Potenza elettrica electric power Elektrische Gesamtleistung Puissance électrique Potencia eléctrica	kW 15 Ac400V-3N ⚡	kW 15 Ac400V-3N ⚡	kW 15 Ac400V-3N ⚡	kW 15 Ac400V-3N ⚡	kW 15 Ac400V-3N ⚡	kW 15 Ac400V-3N ⚡

M 80
cm 80x90x87













IPX5	EXTRA UE		
	Q90FTV/E800	Q90FTV/E810	Q90FTV/E820
	CR1017649	CR1017689	CR1017729
Dim. esterne Ext. dimensions Außenabmessungen Dim. hors-tout Dimensiones exteriores	M 80	M 80	M 80
Dim. piastra Griddle plate dim. Plattenabmessungen Dim. de la plaque Dim. de la planch	cm 73,5 x 53	cm 73,5 x 53	cm 73,5 x 53
Potenza elettrica electric power Elektrische Gesamtleistung Puissance électrique Potencia eléctrica	kW 15 Ac400V-3N ⚡	kW 15 Ac400V-3N ⚡	kW 15 Ac400V-3N ⚡





M 120
cm 120x90x87



IPX5	EXTRA UE					
	Q90FTV/E1203	Q90FTV/E1205	Q90FTV/E1223	Q90FTV/E1225	Q90FTV/E1200	Q90FTV/E1220
	CR1350809	CR1017789	CR1350829	CR1017829	CR1017769	CR1017809
Dim. esterne Ext. dimensions Außenabmessungen Dim. hors-tout Dimensiones exteriores	M 120	M 120	M 120	M 120	M 120	M 120
Dim. piastra Griddle plate dim. Plattenabmessungen Dim. de la plaque Dim. de la planch	cm 113,5 x 53	cm 113,5 x 53	cm 113,5 x 53	cm 113,5 x 53	cm 113,5 x 53	cm 113,5 x 53
Potenza elettrica electric power Elektrische Gesamtleistung Puissance électrique Potencia eléctrica	kW 22.5 Ac400V-3N ⚡	kW 22.5 Ac400V-3N ⚡	kW 22.5 Ac400V-3N ⚡	kW 22.5 Ac400V-3N ⚡	kW 22.5 Ac400V-3N ⚡	kW 22.5 Ac400V-3N ⚡



	Q90BM/G410	Q90BMV/G410	Q90BM/G810	Q90BMV/G800
	CR1017849	CR1017859	CR1017879	CR1017889
				
Dimensioni esterne External dimensions Außenabmessungen Dim. hors-tout Dimensiones exteriores	40x90x25	40x90x87	80x90x25	80x90x87
Dimensioni interne vasche Well internal dimensions Beckeninnenabmes-sungen Dim. intérieures cuves Dimensiones interiores de las cubas	cm 35 x 68,5 17 h	cm 35 x 68,5 17 h	cm 35 x 68,5 17 h	cm 35 x 68,5 17 h
Potenza totale gas Total gas power Gasgesamtleistung Puiss. tot. gaz Pot. total de gas	3kw Kcal 3095 	3kw Kcal 3095 	6kw Kcal 5847 	6kw Kcal 5847 
Capacità norm. recipiente Tank capacity Kesselkapazität Capacité norm. récipient Capacidad nominal cub	1 x GN 1/3 1 x GN 1/1	1 x GN 1/3 1 x GN 1/1	2 x GN 1/3 2 x GN 1/1	2 x GN 1/3 2 x GN 1/1

IPX5	Q90BM/E410	Q90BM/E800	Q90BMV/E410	Q90BMV/E800
	CR1017909	CR1017939	CR1017909	CR1017949
				
Dimensioni esterne External dimensions Außenabmessungen Dim. hors-tout Dimensiones exteriores	40x90x25	40x90x87	80x90x25	80x90x87
Dimensioni interne vasche Well internal dimensions Beckeninnenabmes-sungen Dim. intérieures cuves Dimensiones interiores de las cubas	cm 35 x 68,5 17 h	cm 35 x 68,5 17 h	cm 35 x 68,5 17 h	cm 35 x 68,5 17 h
Potenza totale elettrica Total electric power Elektrische Gesamtleistung Puissance totale électrique Potencia total eléctrica	kw 1,8 	kw 1,8 	kw 5,4 	kw 5,4 
Tensione alimentazione Supply voltage Ansch.-Spann. Tension d'alimentation Tensión de alimentación	230V - 1 N	230V - 1 N	400V - 3 N	400V - 3 N
Capacità norm. recipiente Tank capacity Kesselkapazität Capacité norm. récipient Capacidad nominal cub	1 x GN 1/3 1 x GN 1/1	1 x GN 1/3 1 x GN 1/1	2 x GN 1/3 2 x GN 1/1	2 x GN 1/3 2 x GN 1/1

IPX4	Q90SP/E400	Q90SPV/E400
	CR1017969	CR1017979
		
Capacità/ Capacity / Kapazität / Capacité / Capacidad	GN1/1	GN1/1
Dimensioni esterne / External dimensions / Außenabmessungen / Dim. hors-tout / Dimensiones exteriores	cm 40 x 90 25 h	cm 40 x 90 87 h
Regolazione temperatura / temperature adjustment / Tem- peratureinstellung / ajustement de la température / ajuste de temperatura	30° -90°	30° -90°
Potenza totale elettrica / Total electric power Elektrische Gesamtleistung Puiss. tot. électrique / Potencia total eléctrica	kw 2 	kw 2 
Tensione alimentazione / Supply voltage / Ansch.-Spann. Tension d'alimentation / Tensión de alimentación	230V - 1 N	230V - 1 N

Su vano
On cabinet
Auf unterbau
Sur placard
Sobre base neutra



IPX5	Q90BRF/E605
	CR1018129
	
Dimensioni esterne / External dimensions / Außenabmessungen Dim. hors-tout / Dimensiones exteriores	cm 60 x 90 87 h
Dimensioni interne vasche / Tank internal dimensions Beckenin-nenabmessungen / Dimensions intérieures cuves Dim. interiores de las cubas	cm 52 x 48 9,5 h
Capacità vasca / Tank capacity Fassungsvermögen des Beckens Capacité de la cuve / Capacidad de la cuba	l. 21
Potenza totale elettrica / Total electric power Elektrische Gesamtleistung / Puissance totale électrique Potencia total eléctrica	kw 8,1 
Tensione alimentazione / Supply voltage / Ansch.-Spann. Tension d'alimentation / Tensión de alimentación	400V - 3 N

Pentole / boiling pans / Kochkessel / Marmites / Marmitas

Cottura diretta / Direct heating / direkt beheizt / chauffage direct / calentamiento directo



IPX5	Q90PF/G650	Q90PF/G100	Q90PF/G150	Q90PF/G150A	Q90PF/ED100	Q90PF/ED150
	CR1018039	CR1018009	CR1018029	CR1018059	CR1018099	CR1018109
Funzionamento/ Operation/ Betrieb/ Fonctionnement/ Funcionamiento						
Dimensioni esterne/ External dimensions/ Außenabmessungen/ Dim. hors-tout/ Dimensiones exteriores/	cm 60 x 90 87 h	cm 80 x 90 87 h	cm 80 x 90 87 h	cm 80 x 90 87 h	cm 80 x 90 87 h	cm 80 x 90 87 h
Capacità norm. recipiente/ Rated container capacity/ Norm. Fassungsvermögen des Behälters/ Capacité norm. récipient/ Capacidad nom. del recipiente	l. 50	l. 100	l. 150	l. 150	l. 100	l. 150
Diametro recipiente/ Container diam./ Behälterdurchmesser/ Diamètre du récipient/ Diámetro del recipiente/	cm 39,6	cm 60	cm 60	cm 60	cm 39,6	cm 60
Potenza gas/ Gas power/ Gasleistung/ Puissance gaz/ Potencia de gas/	10.5Kw	21Kw	24Kw	24Kw		
Potenza elettrica/ Electric power/ Elektrische Leistung/ Puiss. électrique/ Potencia eléctrica/	0.015Kw	0.015Kw	0.015Kw	0.015Kw	12Kw	12Kw
Tensione alimentazione/ Supply voltage/ Ansch.-Spann./ Tension d'alimentation/ Tensión de alimentación	230V - 1N	230V - 1N	230V - 1N	230V - 1N	400V - 3N	400V - 3N

cottura indiretta / indirect heating indirekt beheizt / chauffage indirect / calentamiento indirecto



IPX5	Q90PF/G1650	Q90PF/G1100	Q90PF/G1150	Q90PF/G1150A	Q90PF/EI650	Q90PF/EI100	Q90PF/EI150
	CR1018049	CR1018019	CR1017999	CR1018069	CR1018089	CR1018119	CR1018079
Funzionamento/ Operation/ Betrieb/ Fonctionnement/ Funcionamiento							
Dimensioni esterne/ External dimensions/ Außenabmessungen/ Dim. hors-tout/ Dimensiones exteriores/	cm 60 x 90 87 h	cm 80 x 90 87 h	cm 80 x 90 87 h	cm 80 x 90 87 h	cm 60 x 90 87 h	cm 80 x 90 87 h	cm 80 x 90 87 h
Capacità norm. recipiente/ Rated container capacity/ Norm. Fassungsvermögen des Behälters/ Capacité norm. récipient/ Capacidad nom. del recipiente	l. 50	l. 100	l. 150	l. 150	l. 50	l. 100	l. 150
Diametro recipiente/ Container diam./ Behälterdurchmesser/ Diamètre du récipient/ Diámetro del recipiente/	cm 39,6	cm 60	cm 60	cm 60	cm 39,6	cm 60	cm 60
Potenza gas/ Gas power/ Gasleistung/ Puissance gaz/ Potencia de gas/	10.5Kw	21Kw	24Kw	24Kw			
Potenza elettrica/ Electric power/ Elektrische Leistung/ Puiss. électrique/ Potencia eléctrica/	0.2Kw	0.2Kw	0.2Kw	0.2Kw	9.8Kw	21Kw	21Kw
Tensione alimentazione/ Supply voltage/ Ansch.-Spann./ Tension d'alimentation/ Tensión de alimentación	230V - 1N	230V - 1N	230V - 1N	230V - 1N	400V - 3N	400V - 3N	400V - 3N

* AUTOCLAVE

Brasiere ribaltabili con coperchio basculante incernierato / Tilting bratt pans with hinged lid / Kippbratpfannen mit Scharnierdeckel / Sauteuses basculantes avec couvercle basculant articulé / Sartenes basculantes con tapa basculante con bisagras



IPX5	Q90BR/G80	Q90BR/G81	Q90BR/GM80	Q90BR/GM81	Q90BR/GM120	Q90BR/GM121
	CR1018189	CR1018179	CR1018209	CR1018199	CR1018229	CR1018219
Manuale/Manual/ Handrad Manuel/ Manuel						
Motorizzate/Motorized/ Motorantrieb Avec Moteur/ Motorizado						
Materiale vasca Pan material/ Beckenmaterial Matériau de la cuve/ Material de la cuba	Duplex (Inox)	Ferro/ Iron Eisen/ Fer Hierro	Duplex (Inox)	Ferro/ Iron Eisen/ Fer Hierro	Duplex (Inox)	Ferro/ Iron Eisen/ Fer Hierro
Dimensioni esterne External dimensions/ Außenabmessungen/ Dim. hors-tout/ Dimensiones exteriores	cm 80 x 90 87 h	cm 80 x 90 87 h	cm 80 x 90 87 h	cm 80 x 90 87 h	cm 120x 90 87 h	cm 120 x 90 87 h
Dimensioni interne vasche/ Pan internal dim./ Beckeninnenabmessungen/ Dimensions intérieures cuves/ Dim. interiores de las cubas	cm 72,5 x 60 x 20 h	cm 72,5 x 60 x 20 h	cm 72,5 x 60 x 20 h	cm 72,5 x 60 x 20 h	cm 112,5 x 60 x 20 h	cm 112,5 x 60 x 20 h
Capacità vasca Pan capacity/ Fassungsvermögen des Beckens/ Capacité de la cuve/ Capacidad de la cuba	l. 80	l. 80	l. 80	l. 80	l. 120	l. 120
Potenza gas/ Gas power/ Wärmebelastung/ Puissance gaz/ Potencia gas	20Kw Kcal 17200 	20Kw Kcal 17200 	20Kw Kcal 17200 	20Kw Kcal 17200 	24Kw Kcal 20640 	24Kw Kcal 20640
Potenza elettrica/ Electric power/ Elektrische Leistung/ Puiss. électrique/ Potencia eléctrica	kW 0,015 230V - 1N	kW 0,015 230V - 1N	kW 0,015 230V - 1N	kW 0,015 230V - 1N	kW 0,12 230V - 1N	kW 0,12 230V - 1N



IPX5	Q90BR/E80	Q90BR/E81	Q90BR/EM80	Q90BR/EM81	Q90BR/EM120	Q90BR/EM121
	CR1018149	CR1018139	CR1018169	CR1018159	CR1018249	CR1018239
Manuale/Manual/ Handrad Manuel/ Manuel						
Motorizzate/Motorized/ Motorantrieb Avec Moteur/ Motorizado						
Materiale vasca Pan material/ Beckenmaterial Matériau de la cuve/ Material de la cuba	Duplex (Inox)	Ferro/ Iron Eisen/ Fer Hierro	Duplex (Inox)	Ferro/ Iron Eisen/ Fer Hierro	Duplex (Inox)	Ferro/ Iron Eisen/ Fer Hierro
Dimensioni esterne External dimensions/ Außenabmessungen/ Dim. hors-tout/ Dimensiones exteriores	cm 80 x 90 87 h	cm 80 x 90 87 h	cm 80 x 90 87 h	cm 80 x 90 87 h	cm 120x 90 87 h	cm 120 x 90 87 h
Dimensioni interne vasche/ Pan internal dim./ Beckeninnenabmessungen/ Dimensions intérieures cuves/ Dim. interiores de las cubas	cm 72,5 x 60 x 20 h	cm 72,5 x 60 x 20 h	cm 72,5 x 60 x 20 h	cm 72,5 x 60 x 20 h	cm 112,5 x 60 x 20 h	cm 112,5 x 60 x 20 h
Capacità vasca Pan capacity/ Fassungsvermögen des Beckens/ Capacité de la cuve/ Capacidad de la cuba	l. 80	l. 80	l. 80	l. 80	l. 120	l. 120
Tensione alimentazione Supply voltage/ Ansch.-Spann./ Tension d'alimentation/ Tensión de alimentación	Kw 9 	Kw 9 	Kw 9 	Kw 9 	Kw 13.5 	Kw 13.5
Potenza elettrica/ Electric power/ Elektrische Leistung/ Puiss. électrique/ Potencia eléctrica	400V - 3N	400V - 3N	400V - 3N	400V - 3N	400V - 3N	400V - 3N

	Q90CPM/G400 CR1018269	Q90CPM/G800 CR1018289
Dimensioni esterne / External dimensions / Außenabmessungen / Dim. hors-tout / Dimensiones exteriores	cm 40 x 90 87 h	cm 80 x 90 87 h
N° vasche / Number of tanks / Anzahl der Becken / Nombre de cuves / N.º de cubas	1	2
Dimensioni interne vasche / Tank internal dimensions / Beckeninnenabmessungen / Dimensions intérieures cuves / Dim. interiores de las cubas	cm 31 x 51 x 27,5	cm 31 x 51 x 27,5
Capacità vasca / Tank capacity / Fassungsvermögen des Beckens / Capacité de la cuve / Capacidad de la cuba	l. 40	l. 40 + 40
Potenza gas / Gas power / Gasleistung / Puissance gaz / Potencia de gas	kW 14	kW 28

Cuocipasta elettrici / Electric pasta-cooker / Elektronudelkocher / Cuisièurs à pâte électriques / Cuecepastas eléctricos

IPX5		
	Q90CP/E400 CR1018309	Q90CP/E800 CR1018329
Dimensioni esterne / External dimensions / Außenabmessungen / Dim. hors-tout / Dimensiones exteriores	cm 40 x 90 87 h	cm 80 x 90 87 h
N° vasche / Number of tanks / Anzahl der Becken / Nombre de cuves / N.º de cubas	1	2
Dimensioni interne vasche / Tank internal dimensions / Beckeninnenabmessungen / Dimensions intérieures cuves / Dim. interiores de las cubas	cm 31 x 51 x 27,5	cm 31 x 51 x 27,5
Capacità vasca / Tank capacity / Fassungsvermögen des Beckens / Capacité de la cuve / Capacidad de la cuba	l. 40	l. 40 + 40
Potenza elettrica / Electric power / Elektrische Leistung / Puiss. électrique / Potencia eléctrica	kW 9	kW 18
Tensione alimentazione / Supply voltage / Ansch.-Spann. / Tension d'alimentation / Tensión de alimentación	400V - 3N	400V - 3N

	Q90FR/G210 CR1018339	Q90FRI/G415 CR1018349	Q90FRI/G420 CR1018359	Q90FRI/G610 CR1018369	Q90FRI/G815 CR1018379	Q90FRI/G820 CR1018389
Dimensioni esterne / External dimensions / Außenabmessungen / Dim. hors-tout / Dimensiones exteriores	cm 20 x 90 87 h	cm 40 x 90 87 h	cm 40 x 90 87 h	cm 60 x 90 87 h	cm 80 x 90 87 h	cm 80 x 90 87 h
N° vasche / Number of tanks / Anzahl der Becken / Nombre de cuves / N.º de cubas	1	1	1	2	2	2
Capacità vasca / Tank capacity / Fassungsvermögen des Beckens / Capacité de la cuve / Capacidad de la cuba	l.7	l.15	l. 20	l.10+10	l.15+15	l.20+20
Cestelli in dotazione / Baskets equipment / Körbe Ausrüstung / Paniers equipment / Canastos in dotación	n1 12x30x12	n2 24.2x32x12.2	n2 13.8x37.7x12.2	n2 15.7x32x12.2	n4 12x32x122	n4 13.8x37.7x12.2
Potenza gas / Gas power / Gasleistung / Puissance gaz / Potencia de gas	kW 5.8 Kcal 4987	kW 13 Kcal 11178	kW 17.2 Kcal 14800	kW 19 Kcal 16337	kW 26 Kcal 22356	kW 34.4 Kcal 29578
Potenza elettrica / Electric power / Elektrische Leistung / Puiss. électrique / Potencia eléctrica			kW 0.05 230V - 1N			kW 0.1 230V - 1N

Friggitrici elettriche / Electric deep fat fryers / Elektro Friteusen / Friteuses électriques / Freidoras eléctricas

IPX5						
	Q90FR/E210 CR1018399	Q90FRI/E415 CR1018409	Q90FRI/E420 CR1018419	Q90FRI/E610 CR1018429	Q90FRI/E815 CR1018439	Q90FRI/E820 CR1018449
Dimensioni esterne / External dimensions / Außenabmessungen / Dim. hors-tout / Dimensiones exteriores	cm 20 x 90 87 h	cm 40 x 90 87 h	cm 40 x 90 87 h	cm 60 x 90 87 h	cm 80 x 90 87 h	cm 80 x 90 87 h
N° vasche / Number of tanks / Anzahl der Becken / Nombre de cuves / N.º de cubas	1	1	1	2	2	2
Capacità vasca / Tank capacity / Fassungsvermögen des Beckens / Capacité de la cuve / Capacidad de la cuba	l.8	l.15	l. 20	l.10+10	l.15+15	l.20+20
Cestelli in dotazione / Baskets equipment / Körbe Ausrüstung / Paniers equipment / Canastos in dotación	n1 12x30x12	n2 24.2x32x12.2	n2 13.8x37.7x12.2	n2 15.7x32x12.2	n4 12x32x122	n4 13.8x37.7x12.2
Potenza elettrica / Electric power / Elektrische Leistung / Puiss. électrique / Potencia eléctrica	kW 6.8 400V - 3N	kW 13 400V - 3N	kW 18 400V - 3N	kW 18 400V - 3N	kW 26 400V - 3N	kW 36 400V - 3N



IPX5	90FREV/E422	90FREV/E422F	90FREV/E422A	90FREV/E422FA	D9223/10FRGEV	D9223/10FRGEVF	D9223/10FRGEVA	D9223/10FRGEVFA
	CR1209909	CR1209919	CR1209929	CR1209939	CR1209869	CR1209879	CR1209889	CR1209899
Dimensioni esterne External dimensions Außenabmessungen Dim. hors-tout Dimensiones exteriores	cm 40 x 90 87 h	cm 40 x 90 87 h	cm 40 x 90 87 h	cm 40 x 90 87 h	cm 40 x 90 87 h	cm 40 x 90 87 h	cm 40 x 90 87 h	cm 40 x 90 87 h
Kit sistema di filtraggio con pompa per riempire / Built-in filtering system with pump for filling / Kit Filtersystem mit Pumpe zum Füllen / Kit de système de filtrage muni de pompe pour le remplissage / Kit sistema de filtrado con bomba de llenado		●		●		●		●
Kit sollevamento automatico del cesto con timer / Automatic raising of basket with timer / Kit Automatisches Anheben des Korbes mit Timer / Kit de levage automatique du panier avec minuteur / Kit de elevación automática de la cesta con temporizador			●	●			●	●
Dimensioni interne vasche / Tank internal dimensions / Beckeninnenabmessungen / Dimensions intérieures cuves / Dim. interiores de las cubas	cm 34x42x h 32.5	cm 34x42x h 32.5	cm 34x42x h 32.5	cm 34x42x h 32.5	cm 34x42x h 58.5	cm 34x42x h 58.5	cm 34x42x h 58.5	cm 34x42x h 58.5
Capacità vasca Tank capacity Fassungsvermögen des Beckens Capacité de la cuve Capacidad de la cuba	l. 22	l. 22	l. 22	l. 22	l. 23	l. 23	l. 23	l. 23
Cestelli in dotazione Baskets equipment Körbe Ausrüstung Paniers equipment Canastos in dotación	n2 11x36x12	n2 11x36x12	n2 11x36x12	n2 11x36x12	n2 11x36x12	n2 11x36x12	n2 11x36x12	n2 11x36x12
Potenza elettrica Electric power Elektrische Leistung Puiss. électrique Potencia eléctrica	kW ⚡ 22 400V - 3N	kW ⚡ 22 400V - 3N	kW ⚡ 22 400V - 3N	kW ⚡ 22 400V - 3N	kW ⚡ 0.1 230V	kW ⚡ 0.2 230V	kW ⚡ 0.2 230V	kW ⚡ 0.2 230V
Potenza gas Gas power Gasleistung Puissance gaz Potencia de gas	-	-	-	-	kW 🔥 25	kW 🔥 25	kW 🔥 25	kW 🔥 25



	Q90GL/G400	Q90GL/G800	Q90GLV/G400	Q90GLV/G800
	CR1018469	CR1018479	CR1018489	CR1018509
Dimensioni esterne External dimensions Außenabmessungen Dim. hors-tout Dimensiones exteriores	40x90x25	80x90x25	40x90x87	80x90x87
Dimensioni griglia Grill rack dimensions Grillfläche Abm. Dim. de la grille Dim. parilla	cm 39 x 65	cm 79 x 65	cm 39 x 65	cm 79 x 65
Superficie griglia Grill rack surface Grillfläche Ober. Sup. grille Sup. parilla	m2 0,18	m2 0.36	m2 0,18	m2 0.36
Potenza totale gas Total gas power Gasgesamtleistung Puiss. tot. gaz Pot. total de gas	kW 12.5 🔥 Kcal 10750	kW 25 🔥 Kcal 21500	kW 12.5 🔥 Kcal 10750	kW 25 🔥 Kcal 21500

Dotazione standard: 1 griglia carne / Standard equipment: 1 grid for meat / Standard Ausrüstung: 1 Rost für Fleisch / Equipment standard: 1 grille viande / Dotación estándar: 1 parilla para carne

Barbecue / Barbecue / Barbecue / Barbecue / Barbecue



	Q90G/G120	Q90GV/G120
	CR1018529	CR1018539
Dimensioni esterne External dimensions Außenabmessungen Dim. hors-tout Dimensiones exteriores	120x90x25	80x90x25
Dimensioni griglia Grill rack dimensions Grillfläche Abm. Dim. de la grille Dim. parilla	cm 108 x 53,5	cm 108 x 53,5
Superficie griglia Grill rack surface Grillfläche Ober. Sup. grille Sup. parilla	m2 0,57	m2 0,57
Potenza totale gas Total gas power Gasgesamtleistung Puiss. tot. gaz Pot. total de gas	kW 32 🔥 Kcal 27520	kW 32 🔥 Kcal 27520

Top

	Q90NE/200	Q90NE/400	Q90NE/600	Q90NE/800	Q90NEC/410	Q90NEC/610	Q90NEC/810
	CR1018569	CR1018579	CR1018589	CR1018599	CR1018689	CR1018699	CR1018709
Dimensioni esterne External dimensions Außenabmessungen Dim. hors-tout Dim. exteriores	20x90x25	40x90x25	60x90x25	80x90x25	40x90x25	60x90x25	80x90x25
Cassetti / Drawers / Schubladen / Tiroirs / Cajones /					1	1	1
Dimensione interna cassetti Drawer internal dimensions Schubladeninnenabmessungen Dim. int. tiroirs Dim. int. cajones					cm 30,5 x 53,5 10,5 h	cm 50,5 x 53,5 10,5 h	cm 70,5 x 53,5 10,5 h

Su vano
On cabinet
Auf unterbau
Sur placard
Sobre base neutra

	Q90NEV/200	Q90NEV/400	Q90NEV/600	Q90NEV/800	Q90NECV/410	Q90NECV/610	Q90NECV/810
	CR1018609	CR1018629	CR1018649	CR1018669	CR1018719	CR1018739	CR1018759
Dimensioni esterne External dimensions Außenabmessungen Dim. hors-tout Dim. exteriores	20x90x87	40x90x87	60x90x87	80x90x87	40x90x87	60x90x87	80x90x87
Cassetti / Drawers / Schubladen / Tiroirs / Cajones /					1	1	1
Dimensione interna cassetti Drawer internal dimensions Schubladeninnenabmessungen Dim. int. tiroirs Dim. int. cajones					cm 30,5 x 53,5 10,5 h	cm 50,5 x 53,5 10,5 h	cm 70,5 x 53,5 10,5 h

Basi Forno / Oven Bases / Ofenbasen / Bases de four / Bases de horno

	Q90FO/E805	Q90FO/E800	Q90FO/G800
	CR1018789	CR1018779	CR1018799
Dimensioni esterne / External dimensions / Außenabmessungen / Dim. hors-tout / Dim. exteriores /	80x83x62	80x83x62	80x83x62
Funzionamento / Operation / Betrieb / Fonctionnement / Funcionamiento /			
Dimensioni interne forni / Oven internal dimensions / Innenabm. der Backöfen / Dim. int. des fours / Dim. interiores hornos /	cm 530 x 700 x 300	cm 530 x 700 x 300	cm 530 x 700 x 300
Potenza gas / Gas power / Gasleistung / Puissance gaz / Potencia de gas /			kW 8.5 Kcal 7308
Potenza elettrica / Electric power / Elektrische Leistung / Puiss. électrique / Potencia eléctrica /	kW 6	kW 6	
Tensione alimentazione / Supply voltage / Ansch.-Spann. / Tension d'alimentation / Tensión de alimentación /	400V - 3N	400V - 3N	
Predisposto base forno per linea top / Oven base fot top line / Backofenbasis für Tischgeräte / Base four pour plans de cuisson / Horno eléctrico para encimeras /		●	●

● Dimensioni generali

● Versioni top

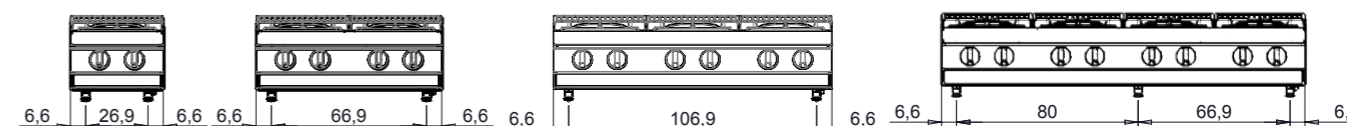

● Versioni su vano

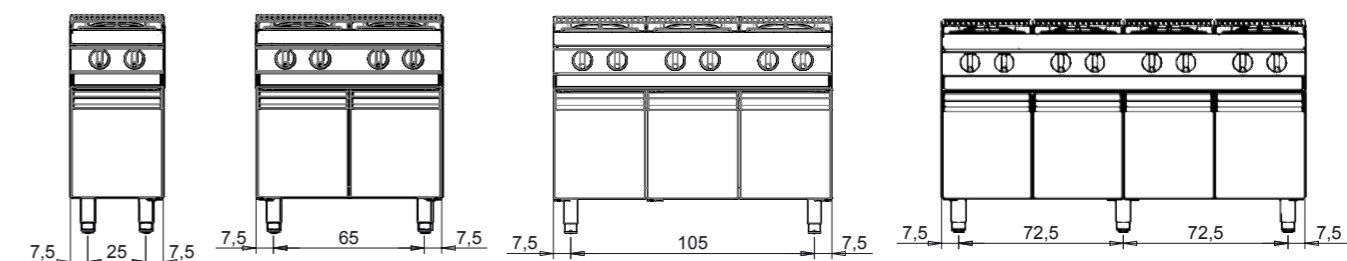

● Versioni su forno

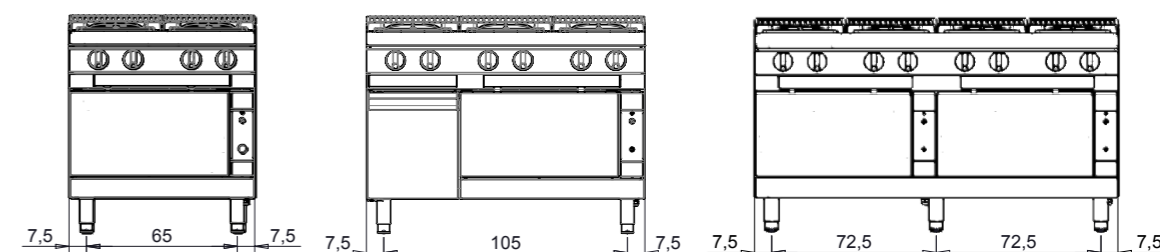

● Sezione laterale

Versione top

Versione top su vano

Versione monoblocco

(Macchine su forno, Talent, Cuocipasta, Friggitrici, Pentole, Brasiere)

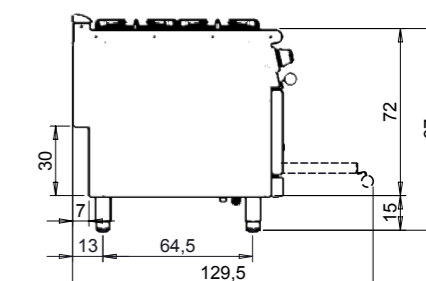
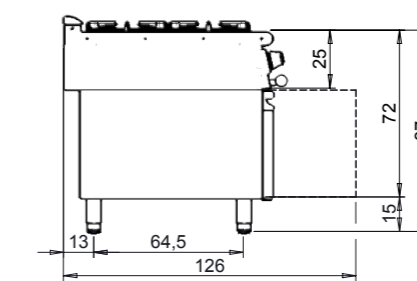
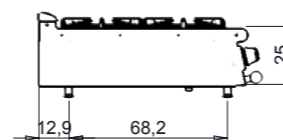



TECHNICAL DATA

Top								
	Q70PC/G4003	Q70PC/G4013	Q70PC/G8008	Q70PC/G8018	Q70PC/G1206	Q70PC/G1216	Q70PC/G1606	Q70PC/G1616
	CR1012209	CR1012219	CR1012229	CR1012239	CR1012249	CR1012259	CR1012269	CR1012279
Dimensioni esterne External dimensions Außenabmessungen Dim. hors-tout Dimensiones exteriores	40x70x25	40x70x25	80x70x25	80x70x25	120x70x25	120x70x25	160x70x25	160x70x25
Bruciatori a gas (versione base) Gas burners (basic configuration) Gasbrenner (Grundausrüstung) Brûleurs gaz (version de base) Quemadores a gas (versión normal)	kW 1 x 3,5 1 x 7	kW 1 x 3,5 1 x 7	kW 4 x 7	kW 4 x 7	kW 2 x 3,5 2 x 7 2x5,7	kW 2 x 3,5 2 x 7 2x5,7	kW 2 x 3,5 2 x 7 4x5,7	kW 2 x 3,5 2 x 7 4x5,7
Potenza totale gas Total gas power Gasgesamtleistung Puissance totale gaz Potencia total de gas	10.5kw Kcal9030	10.5kw Kcal9030	28kw Kcal 24000	28kw Kcal24000	32.4kw Kcal27860	32.4kw Kcal27860	43,8kw Kcal 37700	43.8kw Kcal 37700
Sistema autopulente Water-bath system System selbstreinigend Système auto-nettoyant Sistema de autolimpiantes		●		●		●		●
Su vano On cabinet Auf unterbau Sur placard Sobre base neutra								
	Q70PCV/G4003	Q70PCV/G4013	Q70PCV/G8008	Q70PCV/G8018	Q70PCV/G1206	Q70PCV/G1216	Q70PCV/G1606	Q70PCV/G1616
	CR1012289	CR1012309	CR1012329	CR1012349	CR1012369	CR1012389	CR1012409	CR1012429
Dimensioni esterne External dimensions Außenabmessungen Dim. hors-tout Dimensiones exteriores	40x70x87	40x70x87	80x70x87	80x70x87	120x70x87	120x70x87	160x70x87	160x70x87
Bruciatori a gas (versione base) Gas burners (basic configuration) Gasbrenner (Grundausrüstung) Brûleurs gaz (version de base) Quemadores a gas (versión normal)	kW 1 x 3,5 1 x 7	kW 1 x 3,5 1 x 7	kW 4 x 7	kW 4 x 7	kW 2 x 3,5 2 x 7 2x5,7	kW 2 x 3,5 2 x 7 2x5,7	kW 2 x 3,5 2 x 7 4x5,7	kW 2 x 3,5 2 x 7 4x5,7
Potenza totale gas Total gas power Gasgesamtleistung Puissance totale gaz Potencia total de gas	10.5kw Kcal9030	10.5kw Kcal9030	28kw Kcal 24000	28kw Kcal24000	32.4kw Kcal27860	32.4kw Kcal27860	43,8kw Kcal 37700	43.8kw Kcal 37700
Sistema autopulente Water-bath system System selbstreinigend Système auto-nettoyant Sistema de autolimpiantes		●		●		●		●

Cucine a gas / Gas ranges / Gasherde / Fourneaux gaz / Cocinas a gas



Su Forno/On oven/
Auf backöfen/Sur fours/
En hornos



	Q70PCF/G8008	Q70PCF/GE8018	Q70PCF/G8018	Q70PCF/GE8018	Q70PCFL/G1206	Q70PCFL/G1216
	CR1012449	CR1012479	CR1012469	CR1012479	CR1012529	CR1012539
Dimensioni esterne External dimensions Außenabmessungen Dim. hors-tout Dimensiones exteriores	80x70x87	40x70x87	80x70x87	80x70x87	120x70x87	120x70x87
Bruciatori a gas (versione base) Gas burners (basic configuration) Gasbrenner (Grundausrüstung) Brûleurs gaz (version de base) Quemadores a gas (versión normal)	kW 4 x 7	kW 4 x 7	kW 4 x 7	kW 4 x 7	kW 2 x 3,5 2 x 5,6 2 x 7	kW 2 x 3,5 2 x 5,6 2 x 7
Sistema autopulente Water-bath system System selbstreinigend Système auto-nettoyant Sistema de autolimpiantes		●		●		●
Dimensioni interne forni Oven internal dimensions Innenabm. der Backöfen Dim. int. des fours Dim. interiores hornos	cm 57.2 x 58 x 30 h Grid Dimens. 55x53	cm 57.2 x 58 x 30 h Grid Dimens. 55x53	cm 57.2 x 58 x 30 h Grid Dimens. 55x53	cm 57.2 x 58 x 30 h Grid Dimens. 55x53	cm 79 x 55 x 40h Grid Dimens. 78.4x52	cm 79x55 x 40h Grid Dimens. 78.4x52
Potenza forni a gas Gas oven power Leistung der Gasbacköfen Puissance des fours à gaz Pot. de hornos a gas	6.5kW 🔥		6.5kW 🔥		8 kW 🔥	8 kW 🔥
Potenza forni elettrici Electric oven power Leistung der E-Backöfen Puissance des fours électr. Pot. hornos eléc.		6 kW ⚡		6 kW ⚡		
Potenza totale gas Total gas power Gesamtleistung Puissance totale gaz Potencia total de gas	34.5kw Kcal29700 🔥	28kw Kcal24000 🔥	34.5kw Kcal29700 🔥	28kw Kcal24000 🔥	40.4kw Kcal34800 🔥	40.4kw Kcal34800 🔥
Potenza totale elettrica Total electric power Elektrische Gesamtleistung Puissance totale électrique Potencia total eléctrica		6 kW ⚡		6 kW ⚡		
Tensione alimentazione Supply voltage Ansch.-Spann. Tension d'alimentation Tensión de alimentación		400V - 3 N		400V - 3 N		

Cucine a gas / Gas ranges / Gasherde / Fourneaux gaz / Cocinas a gas



Su Forno/On oven/
Auf backöfen/Sur fours/
En hornos



	Q70PCF/G1206	Q70PCF/GE1206	Q70PCF/G1216	Q70PCF/GE1216	Q70PCF/G1606	Q70PCF/GE1606	Q70PCF/G1616	Q70PCF/GE1616
	CR1012489	CR1012499	CR1012509	CR1012519	CR1012549	CR1012559	CR1012569	CR1012579
Dimensioni esterne External dimensions Außenabmessungen Dim. hors-tout Dimensiones exteriores	cm 120x70x87	cm 120x70x87	cm 120x70x87	cm 120x70x87	cm 160x70x87	cm 160x70x87	cm 160x70x87	cm 160x70x87
Bruciatori a gas (versione base) Gas burners (basic configuration) Gasbrenner (Grundausrüstung) Brûleurs gaz (version de base) Quemadores a gas (versión normal)	kW 2x 3,5 2x5,7 2 x 7	kW 2x 3,5 2x5,7 2 x 7	kW 2x 3,5 2x5,7 2 x 7	kW 2x 3,5 2x5,7 2 x 7	kW 2x 3,5 4x5,7 2 x 7	kW 2x 3,5 4x5,7 2 x 7	kW 2x 3,5 4x5,7 2 x 7	kW 2x 3,5 4x5,7 2 x 7
Sistema autopulente Water-bath system System selbstreinigend Système auto-nettoyant Sistema de autolimpiantes			●	●			●	●
Dimensioni interne forni Oven internal dimensions Innenabm. der Backöfen Dim. int. des fours Dim. interiores hornos	cm 57.2 x 58 x 30 h Grid Dimens. 55x53	cm 57.2 x 58 x 30 h Grid Dimens. 55x53	cm 57.2 x 58 x 30 h Grid Dimens. 55x53	cm 57.2 x 58 x 30 h Grid Dimens. 55x53	2x cm 57.2 x 58 x 30 h Grid Dimens. 55x53	2x cm 57.2 x 58 x 30 h Grid Dimens. 55x53	2x cm 57.2 x 58 x 30 h Grid Dimens. 55x53	2x cm 57.2 x 58 x 30 h Grid Dimens. 55x53
Potenza forni a gas Gas oven power Leistung der Gasbacköfen Puissance des fours à gaz Pot. de hornos a gas	6.5 kW 🔥		6.5 kW 🔥		2x6.5 kW 🔥		2x6.5 kW 🔥	
Potenza forni elettrici Electric oven power Leistung der E-Backöfen Puissance des fours électr. Pot. hornos eléc.		6 kW ⚡		6 kW ⚡		2x6kW ⚡		2x6kW ⚡
Potenza totale gas Total gas power Gesamtleistung Puissance totale gaz Potencia total de gas	38,9kw Kcal 33500 🔥	32,4kw Kcal 33018 🔥	38,9kw Kcal 33500 🔥	32,4kw Kcal 33018 🔥	56,8kw Kcal 48900 🔥	43,8kw Kcal 37700 🔥	56,8kw Kcal 48900 🔥	43,8kw Kcal 37700 🔥
Potenza totale elettrica Total electric power Elektrische Gesamtleistung Puissance totale électrique Potencia total eléctrica		6 kW ⚡		6 kW ⚡		12 kW ⚡		12 kW ⚡
Tensione alimentazione Supply voltage Ansch.-Spann. Tension d'alimentation Tensión de alimentación		400V - 3 N		400V - 3 N		400V - 3 N		400V - 3 N

Cucine a gas - configurazioni bruciatori

Gas ranges - burner configurations / Gasherde - Brenner konfigurierbar /
Fourneaux gaz - brûleurs configurable / Cocinas a gas - quemadores configurable

		3,5 Kw	5,7 Kw	7 Kw
	Vers.1 Standard	1	1	-
	Vers.2	1	-	1
	Vers.3	-	-	2
	Vers.1 Standard	-	-	4
	Vers.2	2	2	-
	Vers.3	1	2	1
	Vers.1 Standard	2	2	2
	Vers.2	3	3	-
	Vers.3	3	1	2
	Vers.1 Standard	2	4	2
	Vers.2	4	4	-
	Vers.3	4	2	2

La disposizione dei bruciatori è libera, all'interno delle potenze certificate / Free position of burners conform to the certified power output / Die Anordnung der Brenner ist frei, innerhalb der zertifizierten Leistungen / La disposition des brûleurs est libre à l'intérieur des puissances certifiées / La distribución de los quemadores es libre dentro de las potencias certificadas

Contattare ufficio tecnico per fattibilità / Please contact sales department for availability / Für Anfragen wenden Sie sich an unsere Verkaufsabteilung / Adressez vous à notre service vente / Contactar nuestro despacho comercial

Griglie a pietra lavica / Lava rock grills / Lavasteingrills / Grilles à pierre volcanique / Barbacoa de piedra lávica



	Q70GL/G400	Q70GL/G800	Q70GLV/G400	Q70GLV/G800
	CR1014919	CR1014929	CR1014939	CR1014959
Dimensioni esterne External dimensions Außenabmessungen Dim. hors-tout Dimensiones exteriores	40x70x25	80x70x25	40x70x87	80x70x87
Dimensioni griglia Grill rack dimensions Grillfläche Abm. Dim. de la grille Dim. parilla	cm 32 x 48	cm 71 x 48	cm 39 x 48	cm 79 x 48
Superficie griglia Grill rack surface Grillfläche Ober. Sup. grille Sup. parilla	m2 0,15	m2 0,30	m2 0,30	m2 0,30
Potenza totale gas Total gas power Gesamtleistung Puiss. tot. gaz Pot. total de gas	kW 10 Kcal 8599	kW 20 Kcal 17197	kW 10 Kcal 8599	kW 20 Kcal 17197

Dotazione standard: 1 griglia carne / Standard equipment: 1 grid for meat / Standard Ausrüstung: 1 Rost für Fleisch / Equipment standard: 1 grille viande /
Dotación estándar: 1 parilla para carne

Wok a gas / Wok gas / Wok Gasherde / Wok gas / Wok gas



	Q70PCV/WG610	Q70PCV/WG614	Q70PCV/WG1020	Q70PCV/WG1028
	CR1012779	CR1012799	CR1012819	CR1012839
Dimensioni esterne External dimensions Außenabmessungen Dim. hors-tout Dimensiones exteriores	cm 60 x 70 87 h	cm 60 x 70 87 h	cm 100 x 70 87 h	cm 100 x 70 87 h
Bruciatori a gas (versione base) Gas burners (basic configuration) Gasbrenner (Grundausstattung) Brûleurs gaz (version de base) Quemadores a gas (versión normal)	10kw	14kw	2x10kw	2x14kw
Potenza totale gas Total gas power Gesamtleistung Puissance totale gaz Potencia total de gas	10kw Kcal8600 	14kw Kcal12040 	20kw Kcal17200 	28kw Kcal24080

Cucine elettriche con piastra in ghisa / Electric range with cast iron plates / Elektroherde mit viereckigen Gussplatten / Fourneaux électriques avec plaques en fonte / Cocinas eléctricas con planchas de hierro fundido



	Q70PC/E400	Q70PC/E800	Q70PC/E120	Q70PCV/E400	Q70PCV/E800	Q70PCV/E120	Q70PCF/E800	Q70PCF/E120
	CR1012589	CR1012599	CR1012609	CR1012619	CR1012639	CR1012659	CR1012679	CR1012689
Dimensioni esterne External dimensions Außenabmessungen Dim. hors-tout Dimensiones exteriores	cm 40 x 70 25 h	cm 80x70 25h	cm 120x 70 25h	cm 40 x 70 87 h	cm 80x70 87 h	cm 120x 70 87 h	cm 80x70 87 h	cm 120x 70 87 h
Dimensioni interne forni Oven internal dimensions Innenabm. der Backöfen Dim. int. des fours Dim. interiores hornos							cm 57.2x58 30 h	cm 57.2x58 30 h
Tipo di piastra Hot plate type Art der Kochplatte Type de plaque Tipo de placa	2 Ø22cm	4 Ø22cm	6 Ø22cm	2 Ø22cm	4 Ø22cm	6 Ø22cm	4 Ø22cm	6 Ø22cm
N° e potenza piastre Hot plate qty. and power Anz. u. Leistung d. Platten Nombre et puiss. des plaques N° y potencia de placas	kW 2 x 2.6	kW 4 x 2.6	kW 6 x 2.6	kW 2 x 2.6	kW 4 x 2.6	kW 6 x 2.6	kW 4 x 2.6	kW 6 x 2.6
Potenza forni elettrici Electric oven power Leistung der Elektrobacköfen Puiss. des fours électriques Potencia hornos eléctricos							kW 6	kW 6
Potenza totale elettrica Total electric power Elektrische Gesamtleistung Puissance totale électrique Potencia total eléctrica	kW5.2 ⚡ 400V - 3 N	kW10.4 ⚡ 400V - 3 N	kW15.6 ⚡ 400V - 3 N	kW5.2 ⚡ 400V - 3 N	kW10.4 ⚡ 400V - 3 N	kW15.6 ⚡ 400V - 3 N	kW16.4 ⚡ 400V - 3 N	kW21.6 ⚡ 400V - 3 N



	Q70PC/E401	Q70PC/E801	Q70PCV/E401	Q70PCV/E801	Q70PCF/E801	Q70PCF/E121
	CR1012699	CR1012709	CR1012719	CR1012739	CR1012759	CR1012769
Dimensioni esterne External dimensions Außenabmessungen Dim. hors-tout Dimensiones exteriores	cm 40 x 70 25 h	cm 80x70 25h	cm 40x 70 87 h	cm 80x 70 87 h	cm 80x 70 87 h	cm 120x 70 87 h
Dimensioni interne forni Oven internal dimensions Innenabm. der Backöfen Dim. int. des fours Dim. interiores hornos				cm 57,3 x 70 29 h		cm 57,3 x 70 29 h
Tipo di piastra Hot plate type Art der Kochplatte Type de plaque Tipo de placa	2 22x22cm	4 22x22cm	2 22x22cm	4 22x22cm	4 22x22cm	6 22x22cm
N° e potenza piastre Hot plate qty. and power Anz. u. Leistung d. Platten Nombre et puiss. des plaques N° y potencia de placas	kW 2 x 2.6	kW 4 x 2.6	kW 2 x 2.6	kW 4 x 2.6	kW 4 x 2.6	kW 6 x 2.6
Potenza forni elettrici Electric oven power Leistung der Elektrobacköfen Puiss. des fours électriques Potencia hornos eléctricos					kW 6	kW 6
Potenza totale elettrica Total electric power Elektrische Gesamtleistung Puissance totale électrique Potencia total eléctrica	5.2 ⚡ kW 400V - 3 N	10.4 ⚡ kW 400V - 3 N	5.2 ⚡ kW 400V - 3 N	10.4 ⚡ kW 400V - 3 N	16.4 ⚡ kW 400V - 3 N	21.6 ⚡ kW 400V - 3 N

Cucine elettriche in vitroceramica / Electric ranges with ceramic glass / Elektroherde Glaskeramik / Plaque Electriques vitro ceramique / Cocinas eléctricas vitroceramica



	Q70PC/VCE400	Q70PC/VCE800	Q70PCV/VCE400	Q70PCV/VCE800	Q70PCF/VCE800
	CR1012959	CR1012989	CR1012969	CR1012999	CR1012949
Dimensioni esterne External dimensions Außenabmessungen Dim. hors-tout Dimensiones exteriores	cm 40 x 70 25 h	cm 80x70 25h	cm 40x 70 87 h	cm 80x 70 87 h	cm 80x 70 87 h
Dimensioni interne forni Oven internal dimensions Innenabm. der Backöfen Dim. int. des fours Dim. interiores hornos					cm 57.2 x 58 x 30 h Grid Dimens. 55x53
Tipo di piastra Hot plate type Art der Kochplatte Type de plaque Tipo de placa	2 23x23cm	4 23x23cm	2 23x23cm	4 23x23cm	4 23x23cm
N° e potenza piastre Hot plate qty. and power Anz. u. Leistung d. Platten Nombre et puiss. des plaques N° y potencia de placas	kW 2.5 x 2	kW 2.5 x 4	kW 2.5 x 2	kW 2.5 x 4	kW 2.5 x 4
Potenza forni elettrici Electric oven power Leistung der Elektrobacköfen Puiss. des fours électriques Potencia hornos eléctricos					kW 6
Potenza totale elettrica Total electric power Elektrische Gesamtleistung Puissance totale électrique Potencia total eléctrica	5 ⚡ kW	10 ⚡ kW	5 ⚡ kW	10 ⚡ kW	16 ⚡ kW
Tensione alimentazione Supply voltage Ansch.-Spann. Tension d'alimentation Tensión de alimentación	400V - 3 N	400V - 3 N	400V - 3 N	400V - 3 N	400V - 3 N



	Q70PC/IND400	Q70PCV/IND400	Q70PC/WOK400	Q70PCV/WOK400	Q70PC/IND800	Q70PCV/IND800
	CR1012889	CR1012899	CR1012859	CR1012869	CR1012919	CR1012929
Dimensioni esterne External dimensions Außenabmessungen Dim. hors-tout Dimensiones exteriores	cm 40 x 70 25 h	cm 40x70 87h	cm 40 x 70 25 h	cm 40x70 87h	cm 80x 70 25 h	cm 80x 70 87 h
Tipo di piastra Hot plate type Art der Kochplatte Type de plaque Tipo de placa	2 zone	2 zone	1 Ø30cm	1 Ø30cm	4 zone	4 zone
N° e potenza piastre Hot plate qty. and power Anz. u. Leistung d. Platten Nombre et puiss. des plaques Nº y potencia de placas	kW 3.5 x 2	kW 3.5 x 2	kW 5x1	kW 5x1	kW 3.5 x4	kW 3.5 x 4
Potenza totale elettrica Total electric power Elektrische Gesamtleistung Puissance totale électrique Potencia total eléctrica	kW 7 	kW 7 	kW 5 	kW 5 	kW 14 	kW 14
Tensione alimentazione Supply voltage Ansch.-Spann. Tension d'alimentation Tensión de alimentación	400V - 3	400V - 3	400V - 3	400V - 3	400V - 3	400V - 3

Tuttapietra Elettrica / Solid top Electric / Elektroherde / Glühplattenherde / Plaque coup-de-feu Electriques / Placa radiante eléctricas



	Q70TP/E800	Q70TPV/E800	Q70TPV/EE800
	CR1013029	CR1013109	CR1013249
Dimensioni esterne External dimensions Außenabmessungen Dim. hors-tout Dimensiones exteriores	cm 80 x 70 25h	cm 80 x 70 87 h	cm 80 x 70 87 h
Potenza resistenza Heating power Beheizungs element Puissance resistences Potencia resistencia	Kw 10	Kw 10	Kw 10
Potenza forno elettrico Electric oven power Leistung des Elektroherds Puissance du four électrique Potencia del horno eléctrico			kW 6
Potenza totale elettrica Total electric power Elektrische Gesamtleistung Puissance totale électrique Potencia total eléctrica	kW 10 	kW 10 	kW 16
Tensione alimentazione Supply voltage Ansch.-Spann. Tension d'alimentation Tensión de alimentación	400V - 3 N	400V - 3 N	400V - 3 N

Top



	Q70TP/G800	Q70TP/G1203SX	Q70TP/G1203DX	Q70TPM/G8003SX	Q70TPM/G1203	Q70TP/G1603
	CR1013019	CR1013039	CR1013049	CR1013069	CR1013079	CR1013059
Dimensioni esterne External dimensions Außenabmessungen Dim. hors-tout Dimensiones exteriores	cm 80 x 70 25 h	cm 120 x 70 25 h	cm 120 x 70 25 h	cm 80 x 70 25 h	cm 120 x 70 25 h	cm 160 x 70 25 h
Potenza bruciatore piastra Solid top plate burner output Leistung des Plattenbrenners Puissance du brûleur de la plaque Potencia del quemador de la plancha	Kw 12	Kw 12	Kw 12	Kw 6	Kw 6	Kw 12
Potenza bruciatori aperti Open burner output Leistung der offenen Brenner Puissance des brûleurs des feux ouverts Potencia de los quemadores abiertos		kW 10,5	kW 10,5	kW 10,5	kW 10,5+10,5	kW 10,5+10,5
Potenza totale gas Total gas power Gasgesamtleistung Puissance totale gaz Potencia total de gas	12kw Kcal 10318 	22.5kw Kcal 19348 	22.5kw Kcal 19348 	16.5kw Kcal 14190 	27kw Kcal 23220 	33kw Kcal 28378

Su vano
On cabinet
Auf unterbau
Sur placard
Sobre base neutra



	Q70TPV/G800	Q70TPV/G1203SX	Q70TPV/G1203DX	Q70TPMV/G8003SX	Q70TPMV/G1203	Q70TPV/G1603
	CR1013089	CR1013129	CR1013149	CR1013189	CR1013209	CR1013169
Dimensioni esterne External dimensions Außenabmessungen Dim. hors-tout Dimensiones exteriores	cm 80 x 70 87 h	cm 120 x 70 87 h	cm 120 x 70 87 h	cm 80 x 70 87 h	cm 120 x 70 87 h	cm 120 x 70 87 h
Potenza bruciatore piastra Solid top plate burner output Leistung des Plattenbrenners Puissance du brûleur de la plaque Potencia del quemador de la plancha	Kw 12	Kw 12	Kw 12	Kw 6	Kw 6	Kw 12
Potenza bruciatori aperti Open burner output Leistung der offenen Brenner Puissance des brûleurs des feux ouverts Potencia de los quemadores abiertos		kW 10,5	kW 10,5	kW 10,5	kW 10,5+10,5	kW 10,5+10,5
Potenza totale gas Total gas power Gasgesamtleistung Puissance totale gaz Potencia total de gas	12kw Kcal 10318 	22.5kw Kcal 19348 	22.5kw Kcal 19348 	16.5kw Kcal 14190 	27kw Kcal 23220 	33kw Kcal 28378

Su Forno/On oven/
Auf backöfen/Sur fours/
En hornos



	Q70TPF/G800	Q70TPF/GE800	Q70TPMF/G8003SX	Q70TPMF/GE8003SX	Q70TP2F/G1603
	CR1013229	CR1013239	CR1013299	CR1013309	CR1013279
Dimensioni esterne External dimensions Außenabmessungen Dim. hors-tout Dimensiones exteriores	cm 80 x 70 87 h	cm 80 x 70 87 h	cm 80 x 70 87 h	cm 80 x 70 87 h	cm 160 x 70 87 h
Dimensioni interne forni Oven internal dimensions Innenabm. der Backöfen Dim. int. des fours Dim. interiores hornos	cm 57.2 x 58 x 30 h Grid Dimens. 55x53	cm 57.2 x 58 x 30 h Grid Dimens. 55x53	cm 57.2 x 58 x 30 h Grid Dimens. 55x53	cm 57.2 x 58 x 30 h Grid Dimens. 55x53	cm 57.2 x 58 x 30 h Grid Dimens. 55x53
Potenza bruciatore piastra Solid top plate burner output Leistung des Plattenbrenners Puissance du brûleur de la plaque Potencia del quemador de la plancha	Kw 12	Kw 12	Kw 6	Kw 6	Kw 12
Potenza bruciatori aperti Open burner output Leistung der offenen Brenner Puissance des brûleurs des feux ouverts Potencia de los quemadores abiertos			kW 10,5	kW 10,5	kW 10,5+10,5
Potenza forno gas Gas oven power Leistung des Gas-backofens Puissance du four à gaz Potencia del horno a gas	Kw 6,5		Kw 6,5		Kw 6,5+6,5
Potenza forno elettrico Electric oven power Leistung des Elektroherds Puissance du four électrique Potencia del horno eléctrico		kW 6		kW 6	
Potenza totale gas Total gas power Gasgesamtleistung Puissance totale gaz Potencia total de gas	18.5kw Kcal 10318+5590 	12kw Kcal 10318 	23kw Kcal 14190+5590 	16,5kw Kcal 14190 	46kw Kcal 28378+5590 +5590
Potenza totale elettrica Total electric power Elektrische Gesamtleistung Puissance totale électrique Potencia total eléctrica		kW 6 		kW 6 	
Tensione alimentazione Supply voltage Ansch.-Spann. Tension d'alimentation Tensión de alimentación		400V - 3 N		400V - 3 N	

Su Forno/On oven/
Auf backöfen/Sur fours/
En hornos



	Q70TP2F/GE1603	Q70TPF/G1203SX	Q70TPF/GE1203SX	Q70TPMF/G1203	Q70TPMF/GE1203
	CR1013289	CR1013259	CR1013269	CR1013319	CR1013329
Dimensioni esterne External dimensions Außenabmessungen Dim. hors-tout Dimensiones exteriores	cm 160 x 70 87 h	cm 120x 70 87 h	cm 120x 70 87 h	cm 120x 70 87 h	cm 120x 70 87 h
Dimensioni interne forni Oven internal dimensions Innenabm. der Backöfen Dim. int. des fours Dim. interiores hornos	cm 57.2 x 58 x 30 h Grid Dimens. 55x53	cm 57.2 x 58 x 30 h Grid Dimens. 55x53	cm 57.2 x 58 x 30 h Grid Dimens. 55x53	cm 57.2 x 58 x 30 h Grid Dimens. 55x53	cm 57.2 x 58 x 30 h Grid Dimens. 55x53
Potenza bruciatore piastra Solid top plate burner output Leistung des Plattenbrenners Puissance du brûleur de la plaque Potencia del quemador de la plancha	Kw 12	Kw 12	Kw 12	Kw 6	Kw 6
Potenza bruciatori aperti Open burner output Leistung der offenen Brenner Puissance des brûleurs des feux ouverts Potencia de los quemadores abiertos	kW 10,5+10,5	kW 10,5	kW 10,5	kW 10,5+10,5	kW 10,5+10,5
Potenza forno gas Gas oven power Leistung des Gas-backofens Puissance du four à gaz Potencia del horno a gas			Kw 6.5	Kw 6.5	
Potenza forno elettrico Electric oven power Leistung des Elektroherds Puissance du four électrique Potencia del horno eléctrico	kW 6+6			kW 6	kW 6
Potenza totale gas Total gas power Gasgesamtleistung Puissance totale gaz Potencia total de gas	33kw Kcal 28378 	29kw Kcal 19348+5590 	22.5kw Kcal 19348 	33.5kw Kcal 23220+5590 	27kw Kcal 23220
Potenza totale elettrica Total electric power Elektrische Gesamtleistung Puissance totale électrique Potencia total eléctrica	kW 12 		kW 6 		kW 6
Tensione alimentazione Supply voltage Ansch.-Spann. Tension d'alimentation Tensión de alimentación	400V - 3 N		400V - 3 N		400V - 3 N

Fry top a gas / Gas griddle plates / Gas-Grillplatten / Grillades gaz / Fry-top gas



M 40
cm 40x70x25



	Q70FT/G403	Q70FTT/G403	Q70FTT/G405	Q70FT/G413	Q70FTT/G413	Q70FTT/G415
	CR1019329	CR1019339	CR1013359	CR1019349	CR1019359	CR1013389
Dim. esterne Ext. dimensions Außenabmessungen Dim. hors-tout Dimensiones exteriores	M 40	M 40	M 40	M 40	M 40	M 40
Dim. piastra Griddle plate dim. Plattenabmessungen Dim. de la plaque Dim. de la planch	cm 33,5 x 53	cm 33,5 x 53	cm 33,5 x 53	cm 33,5 x 53	cm 33,5 x 53	cm 33,5 x 53
Potenza gas Gas power Gasleistung Puissance gaz Potencia de gas	6.5kw Kcal5590 	6.5kw Kcal5590 	6.5kw Kcal5590 	6.5kw Kcal5590 	6.5kw Kcal5590 	6.5kw Kcal5590

Fry top a gas / Gas griddle plates / Gas-Grillplatten / Grillades gaz / Fry-top gas

M 40
cm 40x70x25



	EXTRA UE			
	Q70FT/G400	Q70FTT/G400	Q70FT/G410	Q70FTT/G410
	CR1013339	CR1013349	CR1013369	CR1013379
Dim. esterne Ext. dimensions Außenabmessungen Dim. hors-tout Dimensiones exteriores	M 40	M 40	M 40	M 40
Dim. piastra Griddle plate dim. Plattenabmessungen Dim. de la plaque Dim. de la planch	cm 33,5 x 53	cm 33,5 x 53	cm 33,5 x 53	cm 33,5 x 53
Potenza gas Gas power Gasleistung Puissance gaz Potencia de gas	6.5kw Kcal5590 	6.5kw Kcal5590 	6.5kw Kcal5590 	6.5kw Kcal5590

Fry top a gas / Gas griddle plates / Gas-Grillplatten / Grillades gaz / Fry-top gas



M 80
cm 80x70x25



	Q70FT/G803	Q70FTT/G803	Q70FTT/G805	Q70FT/G813	Q70FTT/G813	Q70FTT/G815	Q70FT/G823	Q70FTT/G823	Q70FTT/G825
	CR1019369	CR1019379	CR1013419	CR1019389	CR1019399	CR1013449	CR1019409	CR1019419	CR1013479
Dim. esterne Ext. dimensions Außenabmessungen Dim. hors-tout Dimensiones exteriores	M80	M80	M80	M80	M80	M80	M80	M80	M80
Dim. piastra Griddle plate dim. Plattenabmessungen Dim. de la plaque Dim. de la planch	cm 73,5 x 53	cm 73,5 x 53	cm 73,5 x 53	cm 73,5 x 53	cm 73,5 x 53	cm 73,5 x 53	cm 73,5 x 53	cm 73,5 x 53	cm 73,5 x 53
Potenza gas Gas power Gasleistung Puissance gaz Potencia de gas	13kw Kcal 11180 	13kw Kcal 11180 	13kw Kcal 11180 	13kw Kcal 11180 	13kw Kcal 11180 	13kw Kcal 11180 	13kw Kcal 11180 	13kw Kcal 11180 	13kw Kcal 11180

M 80
cm 80x70x25



	EXTRA UE					
	Q70FT/G800	Q70FTT/G800	Q70FT/G810	Q70FTT/G810	Q70FT/G820	Q70FTT/G820
	CR1013399	CR1013409	CR1013429	CR1013439	CR1013459	CR1013469
Dim. esterne Ext. dimensions Außenabmessungen Dim. hors-tout Dimensiones exteriores	M80	M80	M80	M80	M80	M80
Dim. piastra Griddle plate dim. Plattenabmessungen Dim. de la plaque Dim. de la planch	cm 73,5 x 53	cm 73,5 x 53	cm 73,5 x 53	cm 73,5 x 53	cm 73,5 x 53	cm 73,5 x 53
Potenza gas Gas power Gasleistung Puissance gaz Potencia de gas	13kw Kcal 11180 	13kw Kcal 11180 	13kw Kcal 11180 	13kw Kcal 11180 	13kw Kcal 11180 	13kw Kcal 11180

M 120
cm 120x70x25



	EXTRA UE					
	Q70FTT/G1203	Q70FTT/G1205	Q70FTT/G1223	Q70FTT/G1225	Q70FTT/G1200	Q70FTT/G1220
	CR1019429	CR1013499	CR1019439	CR1013519	CR1013489	CR1013509
Dim. esterne Ext. dimensions Außenabmessungen Dim. hors-tout Dimensiones exteriores	M120	M120	M120	M120	M120	M120
Dim. piastra Griddle plate dim. Plattenabmessungen Dim. de la plaque Dim. de la planch	cm 113,5 x 53	cm 113,5 x 53	cm 113,5 x 53	cm 113,5 x 53	cm 113,5 x 53	cm 113,5 x 53
Potenza gas Gas power Gasleistung Puissance gaz Potencia de gas	19.5kw Kcal 16767 	19.5kw Kcal 16767 	19.5kw Kcal 16767 	19.5kw Kcal 16767 	19.5kw Kcal 16767 	19.5kw Kcal 16767

Fry top a gas / Gas griddle plates / Gas-Grillplatten / Grillades gaz / Fry-top gas



M 40
cm 40x70x25



	Q70FTV/G403	Q70FTTV/G403	Q70FTTV/G405	Q70FTV/G413	Q70FTTV/G413	Q70FTTV/G415
	CR1019449	CR1019469	CR1013569	CR1019489	CR1019509	CR1013629
Dim. esterne Ext. dimensions Außenabmessungen Dim. hors-tout Dimensiones exteriores	M 40	M 40	M 40	M 40	M 40	M 40
Dim. piastra Griddle plate dim. Plattenabmessungen Dim. de la plaque Dim. de la planch	cm 33,5 x 53	cm 33,5 x 53	cm 33,5 x 53	cm 33,5 x 53	cm 33,5 x 53	cm 33,5 x 53
Potenza gas Gas power Gasleistung Puissance gaz Potencia de gas	6.5kw Kcal5590	6.5kw Kcal5590	6.5kw Kcal5590	6.5kw Kcal5590	6.5kw Kcal5590	6.5kw Kcal5590

M 40
cm 40x70x25



	EXTRA UE			
	Q70FTV/G400	Q70FTTV/G400	Q70FTV/G410	Q70FTTV/G410
	CR1013529	CR1013549	CR1013589	CR1013609
Dim. esterne Ext. dimensions Außenabmessungen Dim. hors-tout Dimensiones exteriores	M 40	M 40	M 40	M 40
Dim. piastra Griddle plate dim. Plattenabmessungen Dim. de la plaque Dim. de la planch	cm 33,5 x 53	cm 33,5 x 53	cm 33,5 x 53	cm 33,5 x 53
Potenza gas Gas power Gasleistung Puissance gaz Potencia de gas	6.5kw Kcal5590	6.5kw Kcal5590	6.5kw Kcal5590	6.5kw Kcal5590

M 80
cm 80x70x87



	Q70FTV/G803	Q70FTTV/G803	Q70FTTV/G805	Q70FTV/G813	Q70FTTV/G813	Q70FTTV/G815	Q70FTV/G823	Q70FTTV/G823	Q70FTTV/G825
	CR1019529	CR1019549	CR1013689	CR1019569	CR1019589	CR1013749	CR1019609	CR1019629	CR1013809
Dim. esterne Ext. dimensions Außenabmessungen Dim. hors-tout Dimensiones exteriores	M80	M80	M80	M80	M80	M80	M80	M80	M80
Dim. piastra Griddle plate dim. Plattenabmessungen Dim. de la plaque Dim. de la planch	cm 73,5 x 53	cm 73,5 x 53	cm 73,5 x 53	cm 73,5 x 53	cm 73,5 x 53	cm 73,5 x 53	cm 73,5 x 53	cm 73,5 x 53	cm 73,5 x 53
Potenza gas Gas power Gasleistung Puissance gaz Potencia de gas	13kw Kcal 11180	13kw Kcal 11180	13kw Kcal 11180	13kw Kcal 11180	13kw Kcal 11180	13kw Kcal 11180	13kw Kcal 11180	13kw Kcal 11180	13kw Kcal 11180

Fry top a gas / Gas griddle plates / Gas-Grillplatten / Grillades gaz / Fry-top gas



M 80
cm 80x70x87



	EXTRA UE					
	Q70FTV/G800	Q70FTTV/G800	Q70FTV/G810	Q70FTTV/G810	Q70FTV/G820	Q70FTTV/G820
	CR1013649	CR1013669	CR1013709	CR1013729	CR1013769	CR1013789
Dim. esterne Ext. dimensions Außenabmessungen Dim. hors-tout Dimensiones exteriores	M80	M80	M80	M80	M80	M80
Dim. piastra Griddle plate dim. Plattenabmessungen Dim. de la plaque Dim. de la planch	cm 73,5 x 53	cm 73,5 x 53	cm 73,5 x 53	cm 73,5 x 53	cm 73,5 x 53	cm 73,5 x 53
Potenza gas Gas power Gasleistung Puissance gaz Potencia de gas	13kw Kcal 11180	13kw Kcal 11180	13kw Kcal 11180	13kw Kcal 11180	13kw Kcal 11180	13kw Kcal 11180

M 80
cm 80x70x87



	EXTRA UE	
	Q70FTV/G800	Q70FTTV/G800
	CR1013649	CR1013669
Dim. esterne Ext. dimensions Außenabmessungen Dim. hors-tout Dimensiones exteriores	M80	M80
Dim. piastra Griddle plate dim. Plattenabmessungen Dim. de la plaque Dim. de la planch	cm 73,5 x 53	cm 73,5 x 53
Potenza forno elettrico Electric oven power Leistung des Elektroherds Puissance du four électrique Potencia del horno eléctrico	kW 6 ⚡ 400V - 3 N	kW 6 ⚡ 400V - 3 N
Potenza gas Gas power Gasleistung Puissance gaz Potencia de gas	13kw Kcal 11180	13kw Kcal 11180

M 120
cm 120x70x87



	EXTRA UE					
	Q70FTTV/G1203	Q70FTTV/G1205	Q70FTTV/G1223	Q70FTTV/G1225	Q70FTTV/G1200	Q70FTTV/G1220
	CR1019649	CR1013849	CR1019669	CR1013889	CR1013829	CR1013869
Dim. esterne Ext. dimensions Außenabmessungen Dim. hors-tout Dimensiones exteriores	M120	M120	M120	M120	M120	M120
Dim. piastra Griddle plate dim. Plattenabmessungen Dim. de la plaque Dim. de la planch	cm 113,5 x 53	cm 113,5 x 53	cm 113,5 x 53	cm 113,5 x 53	cm 113,5 x 53	cm 113,5 x 53
Potenza gas Gas power Gasleistung Puissance gaz Potencia de gas	19.5kw Kcal 16767	19.5kw Kcal 16767	19.5kw Kcal 16767	19.5kw Kcal 16767	19.5kw Kcal 16767	19.5kw Kcal 16767

M 40
cm 40x70x25



	EXTRA UE					
	Q70FT/E403	Q70FT/E405	Q70FT/E413	Q70FT/E415	Q70FT/E400	Q70FT/E410
	CR1019709	CR1013959	CR1019719	CR1013979	CR1013949	CR1013969
Dim. esterne Ext. dimensions Außenabmessungen Dim. hors-tout Dimensiones exteriores	M 40	M 40	M 40	M 40	M 40	M 40
Dim. piastra Griddle plate dim. Plattenabmessungen Dim. de la plaque Dim. de la planch	cm 33,5 x 53	cm 33,5 x 53	cm 33,5 x 53	cm 33,5 x 53	cm 33,5 x 53	cm 33,5 x 53
Potenza elettrica electric power Elektrische Gesamtleistung Puisance électrique Potencia eléctrica	kW 5.4 Ac400V-3N ⚡	kW 5.4 Ac400V-3N ⚡	kW 5.4 Ac400V-3N ⚡	kW 5.4 Ac400V-3N ⚡	kW 5.4 Ac400V-3N ⚡	kW 5.4 Ac400V-3N ⚡

M 60
cm 60x70x25



	EXTRA UE					
	Q70FT/E603	Q70FT/E605	Q70FT/E613	Q70FT/E615	Q70FT/E623	Q70FT/E625
	CR1019729	CR1013999	CR1019739	CR1014019	CR1019749	CR1014039
Dim. esterne Ext. dimensions Außenabmessungen Dim. hors-tout Dimensiones exteriores	M 60	M 60	M 60	M 60	M 60	M 60
Dim. piastra Griddle plate dim. Plattenabmessungen Dim. de la plaque Dim. de la planch	cm 53,5 x 53	cm 53,5 x 53	cm 53,5 x 53	cm 53,5 x 53	cm 53,5 x 53	cm 53,5 x 53
Potenza elettrica electric power Elektrische Gesamtleistung Puisance électrique Potencia eléctrica	kW 7.5 Ac400V-3N ⚡	kW 7.5 Ac400V-3N ⚡	kW 7.5 Ac400V-3N ⚡	kW 7.5 Ac400V-3N ⚡	kW 7.5 Ac400V-3N ⚡	kW 7.5 Ac400V-3N ⚡

M 60
cm 60x70x25



	EXTRA UE		
	Q70FT/E600	Q70FT/E610	Q70FT/E620
	CR1013989	CR1014009	CR1014029
Dim. esterne Ext. dimensions Außenabmessungen Dim. hors-tout Dimensiones exteriores	M 60	M 60	M 60
Dim. piastra Griddle plate dim. Plattenabmessungen Dim. de la plaque Dim. de la planch	cm 53,5 x 53	cm 53,5 x 53	cm 53,5 x 53
Potenza elettrica Electric power Elektrische Gesamtleistung Puisance électrique Potencia eléctrica	kW 7.5 Ac400V-3N ⚡	kW 7.5 Ac400V-3N ⚡	kW 7.5 Ac400V-3N ⚡

M 80
cm 80x70x25



	EXTRA UE					
	Q70FT/E803	Q70FT/E805	Q70FT/E813	Q70FT/E815	Q70FT/E823	Q70FT/E825
	CR1019759	CR1014059	CR1019769	CR1014079	CR1019779	CR1014099
Dim. esterne Ext. dimensions Außenabmessungen Dim. hors-tout Dimensiones exteriores	M 80	M 80	M 80	M 80	M 80	M 80
Dim. piastra Griddle plate dim. Plattenabmessungen Dim. de la plaque Dim. de la planch	cm 73,5 x 53	cm 73,5 x 53	cm 73,5 x 53	cm 73,5 x 53	cm 73,5 x 53	cm 73,5 x 53
Potenza elettrica electric power Elektrische Gesamtleistung Puisance électrique Potencia eléctrica	kW 10.8 Ac400V-3N ⚡	kW 10.8 Ac400V-3N ⚡	kW 10.8 Ac400V-3N ⚡	kW 10.8 Ac400V-3N ⚡	kW 10.8 Ac400V-3N ⚡	kW 10.8 Ac400V-3N ⚡

M 80
cm 80x70x25



	EXTRA UE		
	Q70FT/E800	Q70FT/E810	Q70FT/E820
	CR1014049	CR1014069	CR1014089
Dim. esterne Ext. dimensions Außenabmessungen Dim. hors-tout Dimensiones exteriores	M 80	M 80	M 80
Dim. piastra Griddle plate dim. Plattenabmessungen Dim. de la plaque Dim. de la planch	cm 73,5 x 53	cm 73,5 x 53	cm 73,5 x 53
Potenza elettrica electric power Elektrische Gesamtleistung Puisance électrique Potencia eléctrica	kW 10.8 Ac400V-3N ⚡	kW 10.8 Ac400V-3N ⚡	kW 10.8 Ac400V-3N ⚡

M 120
cm 120x70x25



	EXTRA UE					
	Q70FT/E1203	Q70FT/E1205	Q70FT/E1223	Q70FT/E1225	Q70FT/E1200	Q70FT/E1220
	CR1019789	CR1014119	CR1019799	CR1014139	CR1014109	CR1014129
Dim. esterne Ext. dimensions Außenabmessungen Dim. hors-tout Dimensiones exteriores	M 120	M 120	M 120	M 120	M 120	M 120
Dim. piastra Griddle plate dim. Plattenabmessungen Dim. de la plaque Dim. de la planch	cm 113,5 x 53	cm 113,5 x 53	cm 113,5 x 53	cm 113,5 x 53	cm 113,5 x 53	cm 113,5 x 53
Potenza elettrica electric power Elektrische Gesamtleistung Puisance électrique Potencia eléctrica	kW 16.2 Ac400V-3N ⚡	kW 16.2 Ac400V-3N ⚡	kW 16.2 Ac400V-3N ⚡	kW 16.2 Ac400V-3N ⚡	kW 16.2 Ac400V-3N ⚡	kW 16.2 Ac400V-3N ⚡

M 40
cm 40x70x87



	EXTRA UE					
	Q70FTV/E403	Q70FTV/E405	Q70FTV/E413	Q70FTV/E415	Q70FTV/G400	Q70FTV/G410
	CR1019809	CR1014169	CR1019829	CR1014209	CR1013529	CR1013589
Dim. esterne Ext. dimensions Außenabmessungen Dim. hors-tout Dimensiones exteriores	M 40	M 40	M 40	M 40	M 40	M 40
Dim. piastra Griddle plate dim. Plattenabmessungen Dim. de la plaque Dim. de la planch	cm 33,5 x 53	cm 33,5 x 53	cm 33,5 x 53	cm 33,5 x 53	cm 33,5 x 53	cm 33,5 x 53
Potenza elettrica Electric power Elektrische Gesamtleistung Puissance électrique Potencia eléctrica	kW 5.4 Ac400V-3N ⚡	kW 5.4 Ac400V-3N ⚡	kW 5.4 Ac400V-3N ⚡	kW 5.4 Ac400V-3N ⚡	kW 5.4 Ac400V-3N ⚡	kW 5.4 Ac400V-3N ⚡

M 60
cm 60x70x87



	Q70FTV/E603	Q70FTV/E605	Q70FTV/E613	Q70FTV/E615	Q70FTV/E623	Q70FTV/E625
	CR1019849	CR1014249	CR1019869	CR1014289	CR1019889	CR1014329
Dim. esterne Ext. dimensions Außenabmessungen Dim. hors-tout Dimensiones exteriores	M 60	M 60	M 60	M 60	M 60	M 60
Dim. piastra Griddle plate dim. Plattenabmessungen Dim. de la plaque Dim. de la planch	cm 53,5 x 53	cm 53,5 x 53	cm 53,5 x 53	cm 53,5 x 53	cm 53,5 x 53	cm 53,5 x 53
Potenza elettrica Electric power Elektrische Gesamtleistung Puissance électrique Potencia eléctrica	kW 7.5 Ac400V-3N ⚡	kW 7.5 Ac400V-3N ⚡	kW 7.5 Ac400V-3N ⚡	kW 7.5 Ac400V-3N ⚡	kW 7.5 Ac400V-3N ⚡	kW 7.5 Ac400V-3N ⚡

M 60
cm 60x70x87



	EXTRA UE		
	Q70FT/E600	Q70FT/E610	Q70FT/E620
	CR1013989	CR1014009	CR1014029
Dim. esterne Ext. dimensions Außenabmessungen Dim. hors-tout Dimensiones exteriores	M 60 FE	M 60 FE	M 60 FE
Dim. piastra Griddle plate dim. Plattenabmessungen Dim. de la plaque Dim. de la planch	cm 53,5 x 53	cm 53,5 x 53	cm 53,5 x 53
Potenza elettrica Electric power Elektrische Gesamtleistung Puissance électrique Potencia eléctrica	kW 7.5 Ac400V-3N ⚡	kW 7.5 Ac400V-3N ⚡	kW 7.5 Ac400V-3N ⚡

M 80
cm 80x70x87



	EXTRA UE					
	Q70FTV/E803	Q70FTV/E805	Q70FTV/E813	Q70FTV/E815	Q70FTV/E823	Q70FTV/E825
	CR1019909	CR1014369	CR1019929	CR1014409	CR1019949	CR1014449
Dim. esterne Ext. dimensions Außenabmessungen Dim. hors-tout Dimensiones exteriores	M 80	M 80	M 80	M 80	M 80	M 80
Dim. piastra Griddle plate dim. Plattenabmessungen Dim. de la plaque Dim. de la planch	cm 73,5 x 53	cm 73,5 x 53	cm 73,5 x 53	cm 73,5 x 53	cm 73,5 x 53	cm 73,5 x 53
Potenza elettrica Electric power Elektrische Gesamtleistung Puissance électrique Potencia eléctrica	kW 10.8 Ac400V-3N ⚡	kW 10.8 Ac400V-3N ⚡	kW 10.8 Ac400V-3N ⚡	kW 10.8 Ac400V-3N ⚡	kW 10.8 Ac400V-3N ⚡	kW 10.8 Ac400V-3N ⚡

M 80
cm 80x70x87



	EXTRA UE		
	Q70FTV/E800	Q70FTV/E810	Q70FTV/E820
	CR1014349	CR1014389	CR1014429
Dim. esterne Ext. dimensions Außenabmessungen Dim. hors-tout Dimensiones exteriores	M 80	M 80	M 80
Dim. piastra Griddle plate dim. Plattenabmessungen Dim. de la plaque Dim. de la planch	cm 73,5 x 53	cm 73,5 x 53	cm 73,5 x 53
Potenza elettrica Electric power Elektrische Gesamtleistung Puissance électrique Potencia eléctrica	kW 10.8 Ac400V-3N ⚡	kW 10.8 Ac400V-3N ⚡	kW 10.8 Ac400V-3N ⚡

M 120
cm 120x70x87



	EXTRA UE					
	Q70FTV/E1203	Q70FTV/E1205	Q70FTV/E1223	Q70FTV/E1225	Q70FTV/E1200	Q70FTV/E1220
	CR1019969	CR1014489	CR1019989	CR1014529	CR1014469	CR1014509
Dim. esterne Ext. dimensions Außenabmessungen Dim. hors-tout Dimensiones exteriores	M 120	M 120	M 120	M 120	M 120	M 120
Dim. piastra Griddle plate dim. Plattenabmessungen Dim. de la plaque Dim. de la planch	cm 113,5 x 53	cm 113,5 x 53	cm 113,5 x 53	cm 113,5 x 53	cm 113,5 x 53	cm 113,5 x 53
Potenza elettrica Electric power Elektrische Gesamtleistung Puissance électrique Potencia eléctrica	kW 16.2 Ac400V-3N ⚡	kW 16.2 Ac400V-3N ⚡	kW 16.2 Ac400V-3N ⚡	kW 16.2 Ac400V-3N ⚡	kW 16.2 Ac400V-3N ⚡	kW 16.2 Ac400V-3N ⚡



	Q70GL/G400	Q70GL/G800	Q70GLV/G400	Q70GLV/G800
	CR1014919	CR1014929	CR1014939	CR1014959
Dimensioni esterne External dimensions Außenabmessungen Dim. hors-tout Dimensiones exteriores	cm 40x70 x25h	cm 80x70 x25h	cm 40x70 x87h	cm 80x70 x87h
Dimensioni griglia Grill rack dimensions Grillfläche Abm. Dim. de la grille Dim. parilla	cm 37 x 49	cm 79 x 49	cm 37 x 49	cm 79 x 49
Superficie griglia Grill rack surface Grillfläche Ober. Sup. grille Sup. parilla	m2 0,18	m2 0,38	m2 0,18	m2 0,38
Potenza totale gas Total gas power Gasgesamtleistung Puiss. tot. gaz Pot. total de gas	kW 10 Kcal 8599	kW 20 Kcal 17197	kW 10 Kcal 8599	kW 20 Kcal 17197

Dotazione standard: 1 griglia carne/ Standard equipment: 1 grid for meat / Standard Ausrüstung: 1 Rost für Fleisch / Equipment standard: 1 grille viande /
Dotación estándar: 1 parilla para carne

Bagnomaria elettrici / electric bain maries / elektro Wasserbäder
Bain-marie électrique / Baño maria eléctrico



	Q70BM/E410	Q70BM/E800	Q70BMV/E410	Q70BMV/E800
	CR1014549	CR1014579	CR1014559	CR1014589
Dimensioni esterne External dimensions Außenabmessungen Dim. hors-tout Dimensiones exteriores	40x70x25	40x70x87	80x70x25	80x70x87
Dimensioni interne vasche Well internal dimensions Beckeninnenabmes- sungen Dim. intérieures cuves Dimensiones interiores de las cubas	cm 35 x 51,4 x 16,5 h	cm 35 x 51,4 x 16,5 h	cm 73 x 51,4 x 16,5 h	cm 73 x 51,4 x 16,5 h
Potenza totale elettrica Total electric power Elektrische Gesamtleistung Puissance totale électrique Potencia total eléctrica	kW 1,8	kW 1,8	kW 5,4	kW 5,4
Tensione alimentazione Supply voltage Ansch.-Spann. Tension d'alimentation Tensión de alimentación	230V - 1 N	230V - 1 N	400V - 3 N	400V - 3 N
Capacità norm. recipiente Tank capacity Kesselkapazität Capacité norm. récipient Capacidad nominal cub	1 x GN 1/1	1 x GN 1/1	2 x GN 1/1	2 x GN 1/1



	Q70SP/E400	Q70SPV/E400
	CR1014609	CR1014619
Capacità/Capacity / Kapazität / Capacité / Capacidad	GN1/1	GN1/1
Dimensioni esterne / External dimensions / Außenabmessungen / Dim. hors-tout / Dimensiones exteriores	cm 40 x 70 25 h	cm 40 x 70 87 h
Regolazione temperatura / temperature adjustment / Tem- peratureinstellung / ajustement de la température / ajuste de temperatura	30° -90°	30° -90°
Potenza totale elettrica / Total electric power Elektrische Gesamtleistung Puiss. tot. électrique / Potencia total eléctrica	kW 2	kW 2
Tensione alimentazione / Supply voltage / Ansch.-Spann. Tension d'alimentation / Tensión de alimentación	230V - 1 N	230V - 1 N

Brasiera elettrica multiuso / Electric multi cooking bratt pan / Elektro Multi-Bräter /
Multi-Sauteuse électrique / Sarten Multiplo eléctrico

Su vano
On cabinet
Auf unterbau
Sur placard
Sobre base neutra



	Q70BRF/E405	Q70BRF/E605
	CR1014669	CR1014729
Dimensioni esterne / External dimensions / Außenabmessungen / Dim. hors-tout / Dimensiones exteriores	cm 40 x 70 87 h	cm 60 x 70 87 h
Dimensioni interne vasche / Tank internal dimensions Beckenin-nenabmessungen / Dimensions intérieures cuves Dim. interiores de las cubas	cm 32 x 48 10 h	cm 52 x 48 10 h
Capacità vasca / Tank capacity Fassungsvermögen des Beckens Capacité de la cuve / Capacidad de la cuba	l. 13	l. 21
Potenza totale elettrica / Total electric power Elektrische Gesamtleistung / Puissance totale électrique Potencia total eléctrica	kW 4,05	kW 8,1
Tensione alimentazione / Supply voltage / Ansch.-Spann. Tension d'alimentation / Tensión de alimentación	400V - 3 N	400V - 3 N



	Q70NP/G650 CR1014639	Q70NP/GI650 CR1014649	Q70NP/EI650 CR1014659
Funzionamento Operation Betrieb Fonctionnement Funcionamiento			
Dimensioni esterne External dimensions Außenabmessungen Dim. hors-tout Dimensiones exteriores	cm 60 x 70 87 h	cm 60 x 70 87 h	cm 60 x 70 87 h
Capacità norm. recipiente Rated container capacity Norm. Fassungsvermögen des Behälters Capacité norm. récipient Capacidad nom. del recipiente	l. 50	l. 50	l. 50
Diametro recipiente Container diam. Behälterdurchmesser Diamètre du récipient Diámetro del recipiente	cm 39,6	cm 39,6	cm 39,6
Potenza gas Gas power Gasleistung Puissance gaz Potencia de gas	 10.5Kw	 10.5Kw	
Potenza elettrica Electric power Elektrische Leistung Puiss. électrique Potencia eléctrica	0.2Kw	0.2Kw	 9.8Kw
Tensione alimentazione Supply voltage Ansch.-Spann. Tension d'alimentation Tensión de alimentación	230V - 1N	230V - 1N	400V - 3N
Pentole indirette indirect heating boiling pans Kochkessel indirekt beheizt Marmites chauffage indirect Marmitas con calentamiento indirecto		●	●
Pentole dirette Direct heating boiling pans Kochkessel direkt beheizt Marmites chauffage direct Marmitas con calentamiento directo	●		



	Q70BR/G80 CR1014689	Q70BR/G81 CR1014679
Manuale / Manual / Handrad Manuel / Manuel	●	●
Motorizzate / Motorized / Motorantrieb Avec Moter / Motorizado		
Materiale vasca Pan material / Beckenmaterial Matériau de la cuve / Material de la cuba	Duplex (Inox)	Ferro / Iron Eisen / Fer Hierro
Dimensioni esterne External dimensions / Außenabmessungen / Dim. hors-tout / Dimensiones exteriores	cm 80 x 70 87 h	cm 80 x 70 87 h
Dimensioni interne vasche / Pan internal dim. / Beckeninnenabmessungen / Dimensions intérieures cuves / Dim. interiores de las cubas	cm 72,6 x 43,2 x 20 h	cm 72,6 x 43,2 x 20 h
Capacità vasca Pan capacity / Fassungsvermögen des Beckens / Capacité de la cuve / Capacidad de la cuba	l. 43	l. 43
Potenza gas / Gas power / Wärmebelastung / Puissance gaz / Potencia gas	14Kw Kcal 12038 	14Kw Kcal 12038
Potenza elettrica / Electric power / Elektrische Leistung / Puiss. électrique / Potencia eléctrica	kW 0,2 230V - 1N	kW 0,2 230V - 1N
	Q70BR/E80 CR1014719	Q70BR/E81 CR1014709
Manuale / Manual / Handrad Manuel / Manuel	●	●
Motorizzate / Motorized / Motorantrieb Avec Moter / Motorizado		
Materiale vasca Pan material / Beckenmaterial Matériau de la cuve / Material de la cuba	Duplex (Inox)	Ferro / Iron Eisen / Fer Hierro
Dimensioni esterne External dimensions / Außenabmess- ungen / Dim. hors-tout / Dimensiones exteriores	cm 80 x 70 87 h	cm 80 x 70 87 h
Dimensioni interne vasche / Pan internal dim. / Beckeninnenabmessungen / Dimensions intérieures cuves / Dim. interiores de las cubas	cm 72,6 x 43,2 x 20 h	cm 72,6 x 43,2 x 20 h
Capacità vasca Pan capacity / Fassungsvermögen des Beckens / Capacité de la cuve / Capaci- dad de la cuba	l. 43	l. 43
Tensione alimentazione Supply voltage / Ansch.-Spann. Tension d'alimentation / Tensión de alimentación	Kw 10 	Kw 10
Potenza elettrica / Electric power / Elektrische Leistung / Puiss. électrique / Potencia eléctrica	400V - 3N	400V - 3N



	Q70CPM/G400 CR1019249	Q70CPM/G800 CR1019269
Dimensioni esterne / External dimensions / Außenabmessungen / Dim. hors-tout / Dimensiones exteriores	cm 40 x 70 87 h	cm 80 x 70 87 h
N° vasche / Number of tanks / Anzahl der Becken / Nombre de cuves / N.º de cubas	1	2
Dimensioni interne vasche / Tank internal dimensions / Beckeninnenabmessungen / Dimensions intérieures cuves / Dim. interiores de las cubas	cm 308x342x324	2 x cm 308x342x324
Capacità vasca / Tank capacity / Fassungsvermögen des Beckens / Capacité de la cuve / Capacidad de la cuba	l. 26	l. 26+26
Potenza gas / Gas power / Gasleistung / Puissance gaz / Potencia de gas	kW 13	kW 26

Cuocipasta elettrici / Electric pasta-cooker / Elektronudelkocher / Cuisièurs à pâte électriques / Cuecepastas eléctricos



	Q70BR/E80 CR1014719	Q70BR/E81 CR1014709
Dimensioni esterne / External dimensions / Außenabmessungen / Dim. hors-tout / Dimensiones exteriores	cm 40 x 70 87 h	cm 80 x 70 87 h
N° vasche / Number of tanks / Anzahl der Becken / Nombre de cuves / N.º de cubas	1	2
Dimensioni interne vasche / Tank internal dimensions / Beckeninnenabmessungen / Dimensions intérieures cuves / Dim. interiores de las cubas	cm 308x342x324	2 x cm 308x342x324
Capacità vasca / Tank capacity / Fassungsvermögen des Beckens / Capacité de la cuve / Capacidad de la cuba	l. 26	l. 26+26
Potenza elettrica / Electric power / Elektrische Leistung / Puiss. électrique / Potencia eléctrica	kW 7,5	kW 15
Tensione alimentazione / Supply voltage / Ansch.-Spann. / Tension d'alimentation / Tensión de alimentación	400V - 3N	400V - 3N

Configurazioni a pagina 76 del listino Prezzi



	Q70FR/G210 CR1014829	Q70FRI/G415 CR1014839	Q70FRI/G610 CR1014849	Q70FRI/G815 CR1014859
Dimensioni esterne / External dimensions / Außenabmessungen / Dim. hors-tout / Dimensiones exteriores	cm 20 x 70 87 h	cm 40 x 70 87 h	cm 60 x 70 87 h	cm 80 x 70 87 h
N° vasche / Number of tanks / Anzahl der Becken / Nombre de cuves / N.º de cubas	1	1	2	2
Capacità vasca / Tank capacity / Fassungsvermögen des Beckens / Capacité de la cuve / Capacidad de la cuba	l.7	l.15	l.10+10	l.15+15
Cestelli in dotazione / Baskets equipment / Körbe Ausrüstung / Paniers equipment / Canastos in dotación	n1 12x30x12	n2 24.2x32x12.2	n2 15.7x32x12.2	n4 12x32x12.2
Potenza gas / Gas power / Gasleistung / Puissance gaz / Potencia de gas	kW 5.8 Kcal 4987	kW 13 Kcal 11178	kW 19 Kcal 16337	kW 26 Kcal 22356

Friggitrici elettriche / Electric deep fat fryers / Elektro Friteusen / Friteuses électriques / Freidoras eléctricas



	Q70FR/E210 CR1014869	Q70FRI/E415 CR1014879	Q70FRI/E415M CR1014889	Q70FRI/E610 CR1014899	Q70FRI/E815 CR1014909
Dimensioni esterne / External dimensions / Außenabmessungen / Dim. hors-tout / Dimensiones exteriores	cm 20 x 70 87 h	cm 40 x 70 87 h	cm 40 x 70 87 h	cm 60 x 70 87 h	cm 80 x 70 87 h
N° vasche / Number of tanks / Anzahl der Becken / Nombre de cuves / N.º de cubas	1	1	1	2	2
Capacità vasca / Tank capacity / Fassungsvermögen des Beckens / Capacité de la cuve / Capacidad de la cuba	l.8	l.15	l.15	l.10+10	l.15+15
Cestelli in dotazione / Baskets equipment / Körbe Ausrüstung / Paniers equipment / Canastos in dotación	n1 12x30x12	n2 24.2x32x12.2	n2 24.2x32x12.2	n2 15.7x32x12.2	n4 12x32x12.2
Potenza elettrica / Electric power / Elektrische Leistung / Puiss. électrique / Potencia eléctrica	kW 6.8 400V - 3N	kW 13 400V - 3N	kW 13 400V - 3N	kW 18 400V - 3N	kW 26 400V - 3N

Top



	Q70NE/200	Q70NE/400	Q70NE/600	Q70NE/800	Q70NEC/410	Q70NEC/610	Q70NEC/810
	CR1014979	CR1014989	CR1014999	CR1015009	CR1015099	CR1015109	CR1015119
Dimensioni esterne External dimensions Außenabmessungen Dim. hors-tout Dim. exteriores	20x70x25	40x70x25	60x70x25	80x70x25	40x70x25	60x70x25	80x70x25
Cassetti / Drawers / Schubladen / Tiroirs / Cajones /					1	1	1
Dimensione interna cassetti Drawer internal dimensions Schubladeninnenabmessungen Dim. int. tiroirs Dim. int. cajones					cm 30,5 x 53,5 10,5 h	cm 50,5 x 53,5 10,5 h	cm 70,5 x 53,5 10,5 h

Su vano
On cabinet
Auf unterbau
Sur placard
Sobre base neutra



	Q70NE/200	Q70NE/400	Q70NE/600	Q70NE/800	Q70NEC/410	Q70NEC/610	Q70NEC/810
	CR1014979	CR1014989	CR1014999	CR1015009	CR1015099	CR1015109	CR1015119
Dimensioni esterne External dimensions Außenabmessungen Dim. hors-tout Dim. exteriores	20x70x87	40x70x87	60x70x87	80x70x87	40x70x87	60x70x87	80x70x87
Cassetti / Drawers / Schubladen / Tiroirs / Cajones /					1	1	1
Dimensione interna cassetti Drawer internal dimensions Schubladeninnenabmessungen Dim. int. tiroirs Dim. int. cajones					cm 30,5 x 53,5 10,5 h	cm 50,5 x 53,5 10,5 h	cm 70,5 x 53,5 10,5 h

Basi Forno / Oven Bases / Ofenbasen / Bases de four / Bases de horno



	Q70FO/E805	Q70FO/E800	Q70FO/G800
	CR1015199	CR1015189	CR1015209
Dimensioni esterne / External dimensions / Außenabmessungen / Dim. hors-tout / Dim. exteriores /	80x83x62	80x83x62	80x83x62
Funzionamento / Operation / Betrieb / Fonctionnement / Funcionamiento /			
Dimensioni interne forni / Oven internal dimensions / Innenabm. der Backöfen / Dim. int. des fours / Dim. interiores hornos /	cm 57.2 x 58 x 30 h Grid Dimens. 55x53	cm 57.2 x 58 x 30 h Grid Dimens. 55x53	cm 57.2 x 58 x 30 h Grid Dimens. 55x53
Potenza gas / Gas power / Gasleistung / Puissance gaz / Potencia de gas /			kw 6.5 Kcal 5589
Potenza elettrica / Electric power / Elektrische Leistung / Puiss. électrique / Potencia eléctrica /	kw 6	kw 6	
Tensione alimentazione / Supply voltage / Ansch.-Spann. / Tension d'alimentation / Tensión de alimentación /	400V - 3N	400V - 3N	
Predisposto base forno per linea top / Oven base fot top line / Backofenbasis für Tischgeräte / Base four pour plans de cuisson / Horno eléctrico para encimeras /			

● Dimensioni generali

● Versioni top

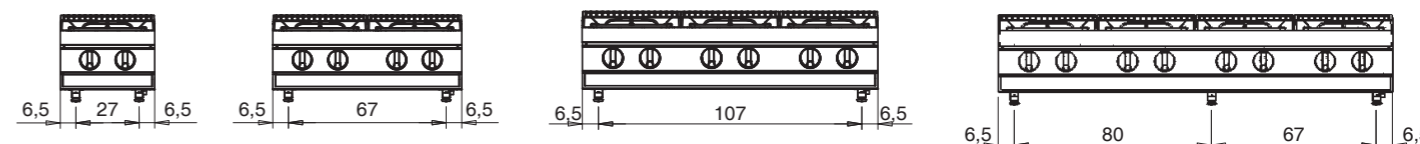

● Versioni su vano

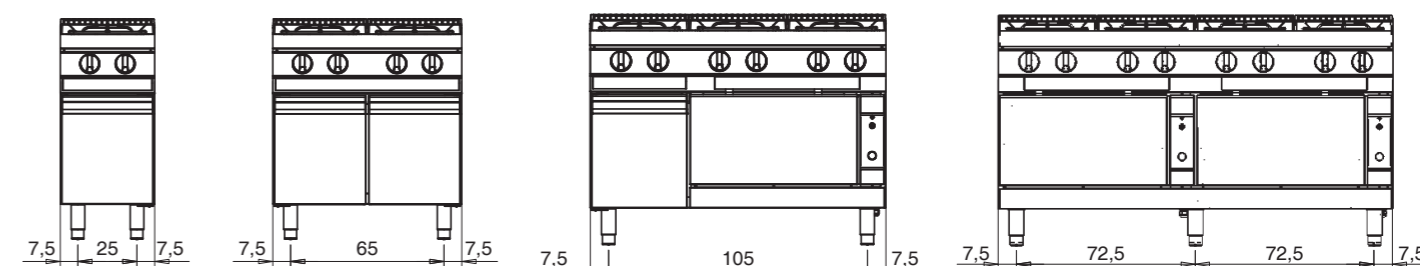

● Versioni su forno

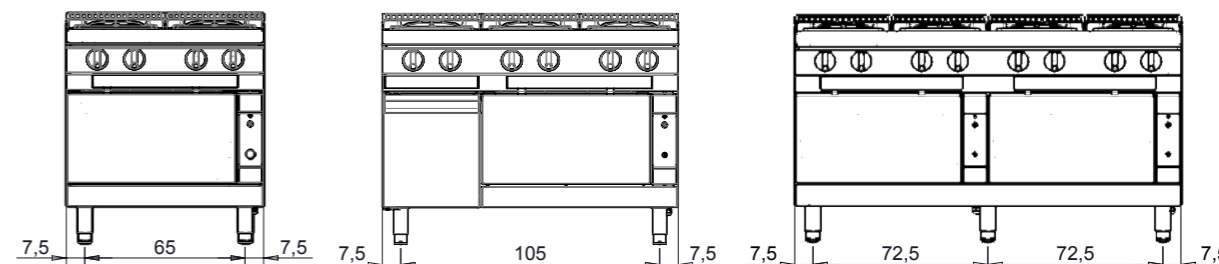

● Sezione laterale

Versione top

Versione top su vano

Versione monoblocco
(Macchine su forno, Talent, Cuocipasta, Friggitrici,
Pentole, Brasiere)

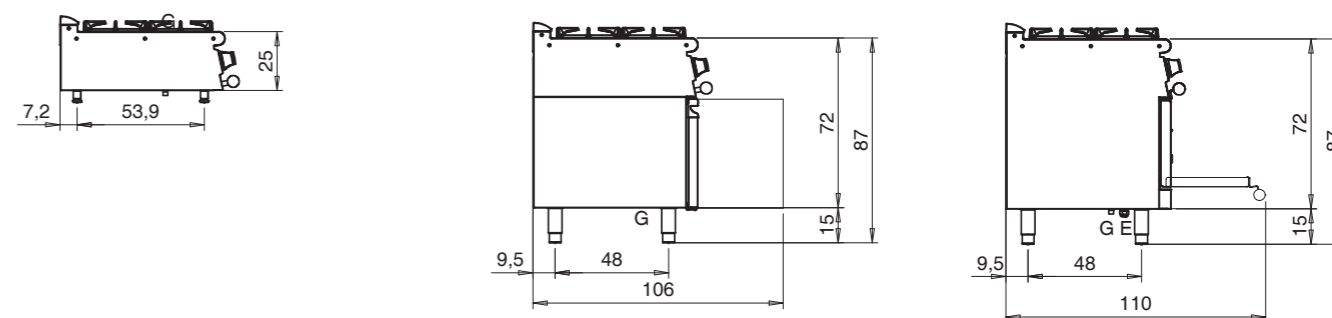



baron

Drop-In7



TECHNICAL DATA





Cucine a gas / Gas ranges / Gasherde / Fourneaux gaz / Cocinas a gas



	DI7PCG40 CR1207609	DI7PCG80 CR1207619
Dimensioni esterne External dimensions Außenabmessungen Dim. hors-tout Dimensiones exteriores	40x62,5x25	80x62,5x25
Bruciatori a gas (versione base) Gas burners (basic configuration) Gasbrenner (Grundausstattung) Brûleurs gaz (version de base) Quemadores a gas (versión normal)	kW 1 x 3.5 1 x 5.6	kW 2 x 3.5 2 x 5.6
Potenza totale gas Total gas power Gasgesamtleistung Puissance totale gaz Potencia total de gas	9,1kW Kcal7824	18,2kW Kcal15649

Cucine elettriche a induzione / Electric induction ranges / Elektrische Induktionsherde / Electriques induction / Cocinas eléctricas a inducción



	DI7PCIND400 CR1207769	DI7PCWI400 CR1207779
Dimensioni esterne / External dimensions / Außenabmessungen / Dim. hors-tout / Dimensiones exteriores /	cm 40x62,5x25	cm 40x62,5x25
Tipo di piastra / Hot plate type / Art der Kochplatte / Type de plaque / Tipo de placa /	 2 Ø23cm	 1 Ø23cm
N° e potenza piastre / Hot plate qty. and power / Anz. u. Leistung d. Platten / Nombre et puiss. des plaques / N° y potencia de placas /	kW 3.5 x 2	kW 5x1
Potenza totale elettrica / Total electric power / Elektrische Gesamtleistung / Puissance totale électrique / Potencia total eléctrica	kW 	kW 
Tensione alimentazione / Supply voltage / Ansch.-Spann. / Tension d'alimentation / Tensión de alimentación /	400V - 3	400V - 3

Bagnomaria elettrici / electric bain maries / elektro Wasserbäder
Bain-marie électrique / Baño maria eléctrico

	DI7BME400 CR1207759
Dimensioni esterne / External dimensions / Außenabmessungen / Dim. hors-tout / Dimensiones exteriores /	cm 40x62,5 25h
Dimensioni interne vasche / Well internal dimensions / Beckeninnenabmessungen / Dim. intérieures cuves / Dimensiones interiores de las cubas	cm 35 x 51,4 x 16,5 h
Potenza totale elettrica / Total electric power / Elektrische Gesamtleistung / Puissance totale électrique / Potencia total eléctrica	kW 1,8 
Tensione alimentazione / Supply voltage / Ansch.-Spann. / Tension d'alimentation / Tensión de alimentación /	230V - 1 N
Capacità norm. recipiente / Tank capacity / Kasselkapazität / Capacité norm. récipient / Capacidad nominal cub	1 x GN 1/1

Fry top elettrici Piastra cromata / Electric griddle Chromium plate / Elektro-Grillplatten Chromplatte / Grillade électriques chromée / Fry-top eléctricos Plancha cromada

Drop-In7

M 40
cm 40x62.5x25



	DI7FTE405 CR1207669	DI7FTE415 CR1207679
Dim. esterne Ext. dimensions Außenabmessungen Dim. hors-tout Dimensiones exteriores	M 40	M 40
Dim. piastra Griddle plate dim. Plattenabmessungen Dim. de la plaque Dim. de la planch	cm 33.5 x 53	cm 33.5 x 53
Potenza elettrica Electric power Elektrische Gesamtleistung Puissance électrique Potencia eléctrica	kW 5.4 Ac400V-3N ⚡	kW 5.4 Ac400V-3N ⚡

M 60
cm 60x62.5x25



	DI7FTE605 CR1207682	DI7FTE615 CR1207699
Dim. esterne Ext. dimensions Außenabmessungen Dim. hors-tout Dimensiones exteriores	M 60	M 60
Dim. piastra Griddle plate dim. Plattenabmessungen Dim. de la plaque Dim. de la planch	cm 53.5x53	cm 53.5x53
Potenza elettrica Electric power Elektrische Gesamtleistung Puissance électrique Potencia eléctrica	kW 7.5 Ac400V-3N ⚡	kW 7.5 Ac400V-3N ⚡

M 80
cm 80x62.5x25



	DI7FTE805 CR1207709	DI7FTE815 CR1207719	DI7FTE825 CR1207729
Dim. esterne Ext. dimensions Außenabmessungen Dim. hors-tout Dimensiones exteriores	M80	M80	M80
Dim. piastra Griddle plate dim. Plattenabmessungen Dim. de la plaque Dim. de la planch	cm 73.5x53	cm 73.5x53	cm 73.5x53
Potenza elettrica Electric power Elektrische Gesamtleistung Puissance électrique Potencia eléctrica	kW 10.8 Ac400V-3N ⚡	kW 10.8 Ac400V-3N ⚡	kW 10.8 Ac400V-3N ⚡

Cuocipasta elettrici / Electric pasta-cooker / Elektronudelkocher / Cuisièurs à pâte électriques / Cuecepastas eléctricos

Drop-In7



	DI7CPE428 CR1207649	DI7CPE642 CR1207659
Dimensioni esterne / External dimensions / Außenabmessungen Dim. hors-tout / Dimensiones exteriores	cm 40 x 62.5 56 h	cm 60 x 62.5 56 h
N° vasche / Number of tanks / Anzahl der Becken / Nombre de cuves / N.º de cubas	1	1
Dimensioni interne vasche / Tank internal dimensions / Beckeninnenabmessungen / Dimensions intérieures cuves / Dim. interiores de las cubas	cm 31x27 x32h	cm 47x37 x32h
Capacità vasca / Tank capacity / Fassungsvermögen des Beckens / Capacité de la cuve / Capacidad de la cuba	l. 28	l. 42
Potenza elettrica / Electric power / Elektrische Leistung / Puiss. électrique / Potencia eléctrica	kW 5,6 ⚡	kW 9 ⚡
Tensione alimentazione / Supply voltage / Ansch.-Spann. / Tension d'alimentation / Tensión de alimentación	400V - 3N	400V - 3N

Friggitrici elettriche / Electric deep fat fryers / Elektro Friteusen / Friteuses électriques / Freidoras eléctricas



	DI7FRE410 CR1207629	DI7FRE415 CR1207639
Dimensioni esterne External dimensions Außenabmessungen Dim. hors-tout Dimensiones exteriores	cm 40 x 62.5 34 h	cm 40 x 62.5 49.8 h
N° vasche Number of tanks Anzahl der Becken Nombre de cuves N.º de cubas	1	1
Capacità vasca Tank capacity Fassungsvermögen des Beckens Capacité de la cuve Capacidad de la cuba	l.10	l.15
Cestelli in dotazione Baskets equipment Körbe Ausrüstung Paniers equipment Canastos in dotación	-	-
Potenza elettrica Electric power Elektrische Leistung Puiss. électrique Potencia eléctrica	kW 9 400V - 3N ⚡	kW 12 400V - 3N ⚡

Brasiera elettrica multiuso / Electric multi cooking bratt pan / Elektro Multi-Bräter / Multi-Sauteuse électrique / Sarten Multiplo eléctrico

	DI7BRF400 CR1207789	DI7BRF600 CR1207799
Dimensioni esterne / External dimensions / Außenabmessungen Dim. hors-tout / Dimensiones exteriores	cm 40 x 62.5 25 h	cm 60 x 62.5 25 h
Dimensioni interne vasche / Tank internal dimensions Beckenin-nenabmessungen / Dimensions intérieures cuves Dim. interiores de las cubas	cm 32 x 48 9 h	cm 52 x 48 9 h
Capacità vasca / Tank capacity Fassungsvermögen des Beckens Capacité de la cuve / Capacidad de la cuba	l. 13	l. 21
Potenza totale elettrica / Total electric power Elektrische Gesamtleistung / Puissance totale électrique Potencia total eléctrica	kW 4.05	kW 8,1
Tensione alimentazione / Supply voltage / Ansch.-Spann. Tension d'alimentation / Tensión de alimentación	400V - 3 N	400V - 3 N

Griglie elettriche dirette / Electric direct grill/ Direkte Elektrogrills / Parrillas eléctricas directas / Grilles électriques directes

	DI7CWE400 CR1207739	DI7CWE800 CR1207749
Dimensioni esterne External dimensions Außenabmessungen Dim. hors-tout Dimensiones exteriores	cm 40x62.5 25h	cm 80x62.5 25h
Dimensioni griglia Grill rack dimensions Grillfläche Abm. Dim. de la grille Dim. parilla	cm 28X45	cm 56X45
Potenza totale elettrica Total electric power Elektrische Gesamtleistung Puissance totale électrique Potencia total eléctrica	kW 6	kW 12
Tensione alimentazione Supply voltage Ansch.-Spann. Tension d'alimentation Tensión de alimentación	400V - 3 N	400V - 3 N

Schema di installazione a filopiano / LINED UP installation / Flächenbündiger Einbau / Instalación a hilo de la encimera / Installation à surface plane

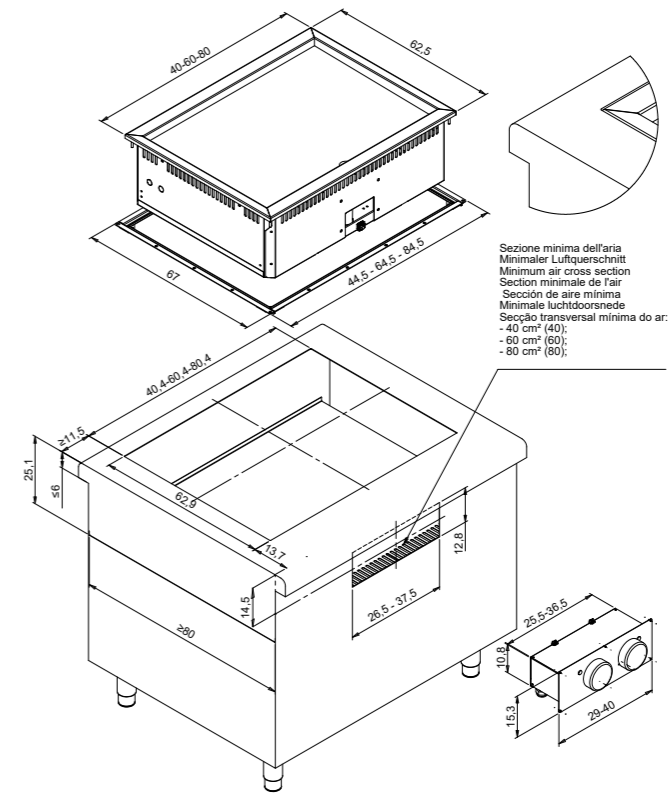

Schema di installazione in appoggio / Top-mount installation / Aufliegende Struktur / Instalación de apoyo / Installation en appui

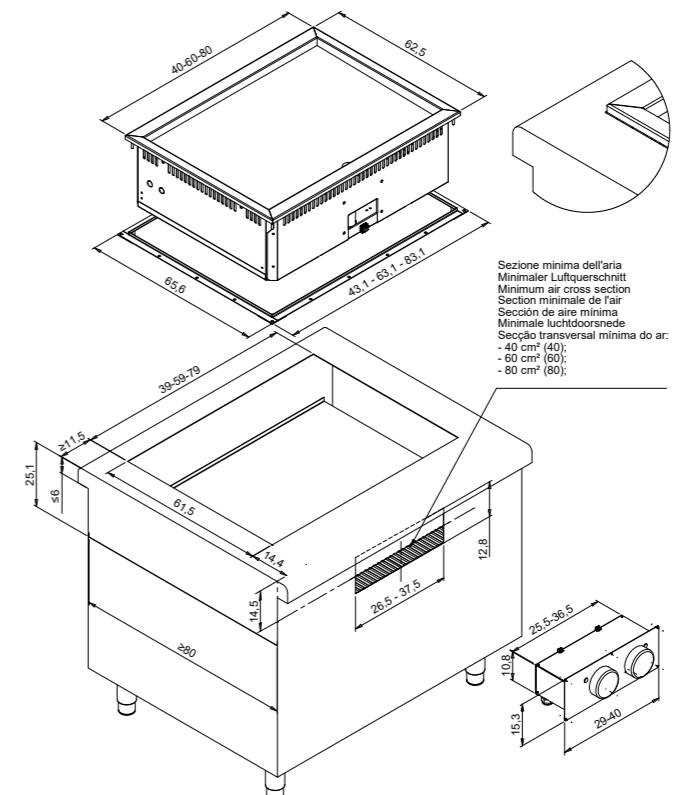



SERIE GIANO



TECHNICAL DATA

Cucine a gas / Gas ranges / Gasherde / Fourneaux gaz / Cocinas a gas

Top



	N550PC/G9003	N550PC/G9013	N1100PC/G4503	N1100PC/G4513	N1100PC/G9003	N1100PC/G9013	N1100PC/G1303	N1100PC/G1313
	CR1011269	CR1011939	CR1011579	CR1011949	CR1011589	CR101959	CR1011599	CR1011969
Dimensioni esterne External dimensions Außenabmessungen Dim. hors-tout Dim. exteriores	90x55x28	90x55x28	45x110x28	45x110x28	90x110x28	90x110x28	135x110x28	135x110x28
Bruciatori a gas (versione base) Gas burners (basic configuration) Gasbrenner (Grundausstattung) Brûleurs gaz (version de base) Quemadores a gas (versión normal)	kW 1 x 10 1 x 5.7	kW 1 x 10 1 x 5.7	kW 1 x 7 1 x 7	kW 1 x 7 1 x 7	kW 2 x 10 2x5,7	kW 2 x 10 2x5,7	kW 2 x 3,5 2x5,7 2x10	kW 2 x 3,5 2x5,7 2x10
Potenza totale gas Total gas power Gasgesamtleistung Puissance totale gaz Potencia total de gas	15.7kw Kcal12900	15.7kw Kcal12900	14kw Kcal12040	14kw Kcal12040	31.4kw Kcal27000	31.4kw Kcal27000	38.4kw Kcal 33000	38.4kw Kcal 33000
Sistema autopulente Water-bath system System selbstreinigend Système auto-nettoyant Sistema de autolimpiantes		●		●		●		●

Su vano
On cabinet
Auf unterbau
Sur placard
Sobre base neutra



	N550PCV/G9003	N550PCVP/G9003	N550PCV/G9013	N550PCVP/G9013	N1100PCV/G4503	N1100PCVP/G4503	N1100PCV/G4513	N1100PCVP/G4513
	CR1011609	CR1011619	CR1011979	CR1011989	CR1011629	CR1011639	CR1011999	CR1012009
Dimensioni esterne External dimensions Außenabmessungen Dim. hors-tout Dimensiones exteriores	90x55x86/90	90x55x86/90	90x55x86/90	90x55x86/90	45x90x87	45x90x87	45x90x87	45x90x87
Bruciatori a gas (versione base) Gas burners (basic configuration) Gasbrenner (Grundausstattung) Brûleurs gaz (version de base) Quemadores a gas (versión normal)	kW 1 x 10 1 x 5.7	kW 1 x 10 1 x 5.7	kW 1 x 10 1 x 5.7	kW 1 x 10 1 x 5.7	kW 2 x 7	kW 2 x 7	kW 2 x 7	kW 2 x 7
Potenza totale gas Total gas power Gasgesamtleistung Puissance totale gaz Potencia total de gas	15.7kw Kcal12900	15.7kw Kcal12900	15.7kw Kcal12900	15.7kw Kcal12900	14kw Kcal12040	14kw Kcal12040	14kw Kcal12040	14kw Kcal12040
Sistema autopulente Water-bath system System selbstreinigend Système auto-nettoyant Sistema de autolimpiantes			●	●			●	●
con porte with doors vec des portes mit Türen con puertas	-	2	-	2	-	2	-	2

Su vano
On cabinet
Auf unterbau
Sur placard
Sobre base neutra



	N1100PCV/G9003	N1100PCVP/G9003	N1100PCV/G9013	N1100PCVP/G9013	N1100PCV/G1303	N1100PCVP/G1303	N1100PCV/G1313	N1100PCVP/G1313
	CR1011649	CR1011659	CR1012019	CR1012029	CR1011669	CR1011679	CR1012039	CR1012049
Dimensioni esterne External dimensions Außenabmessungen Dim. hors-tout Dimensiones exteriores	90x110x86/90	90x110x86/90	90x110x86/90	90x110x86/90	135x110x86/90	135x110x86/90	135x110x86/90	135x110x86/90
Bruciatori a gas (versione base) Gas burners (basic configuration) Gasbrenner (Grundausstattung) Brûleurs gaz (version de base) Quemadores a gas (versión normal)	kW 1x5.7 2x7 1x10	kW 1x5.7 2x7 1x10	kW 1x5.7 2x7 1x10	kW 1x5.7 2x7 1x10	kW 2x3.5 2x5.7 2x10	kW 2x3.5 2x5.7 2x10	kW 2x3.5 2x5.7 2x10	kW 2x3.5 2x5.7 2x10
Potenza totale gas Total gas power Gesamtleistung Puissance totale gaz Potencia total de gas	29.7kw Kcal25537	29.7kw Kcal25537	29.7kw Kcal25537	29.7kw Kcal25537	38.4kw Kcal33000	38.4kw Kcal33000	38.4kw Kcal33000	38.4kw Kcal33000
Sistema autopulente Water-bath system System selbstreinigend Système auto-nettoyant Sistema de autolimpiantes			●	●			●	●
Con porte With doors Vec des portes Mit Türen Con puertas	-	4	-	4	-	6	-	6





Su Forno/On oven/
Auf backöfen/Sur fours/
En hornos



	N1100PCF/G9003	N1100PCF/G9013	N1100PCF/GE9003	N1100PCF/GE9013	N1100PCF/G1303	N1100PCF/G1313	N1100PCF/GE1303	N1100PCF/GE1313
	CR1011689	CR1012059	CR1011699	CR1012069	CR1011709	CR1012079	CR1011719	CR1012089
Dimensioni esterne External dimensions Außenabmessungen Dim. hors-tout Dimensiones exteriores	cm 90x110 x86/90	cm 90x110 x86/90	cm 90x110 x86/90	cm 90x110 x86/90	cm 135x110 x86/90	cm 135x110 x86/90	cm 135x110 x86/90	cm 135x110 x86/90
Bruciatori a gas (versione base) Gas burners (basic configuration) Gasbrenner (Grundausstattung) Brûleurs gaz (version de base) Quemadores a gas (versión normal)	kW 1x5,7 2 x 7 1X10	kW 1x5,7 2 x 7 1X10	kW 1x5,7 2 x 7 1X10	kW 1x5,7 2 x 7 1X10	kW 2x3.5 2x5,7 2 x 10	kW 2x3.5 2x5,7 2 x 10	kW 2x3.5 2x5,7 2 x 10	kW 2x3.5 2x5,7 2 x 10
Potenza forni a gas Gas oven power Leistung der Gasbacköfen Puissance des fours à gaz Pot. de hornos a gas	11 kw	11 kw			11 kw	11 kw		
Potenza forni elettrici Electric oven power Leistung der E-Backöfen Puissance des fours électr. Pot. hornos eléc.			9 kW	9 kW			9 kW	9 kW
Potenza totale gas Total gas power Gesamtleistung Puissance totale gaz Potencia total de gas	29.7+ 11kw Kcal 25537 + 9458	29.7+ 11kw Kcal 25537 + 9458	29.7+ 11kw Kcal 25537	29.7+ 11kw Kcal 25537	38.4+ 11kw Kcal 33000 + 9458	38.4+ 11kw Kcal 33000 + 9458	38.4Kw Kcal 33000	38.4Kw Kcal 33000
Potenza totale elettrica Total electric power Elektrische Gesamtleistung Puissance totale électrique Potencia total eléctrica			9 kW	9 kW			9 kW	9 kW
Tensione alimentazione Supply voltage Ansch.-Spann. Tension d'alimentation Tensión de alimentación			400V - 3 N	400V - 3 N			400V - 3 N	400V - 3 N

Cucine a gas - configurazioni bruciatori

Gas ranges - burner configurations / Gasherde - Brenner konfigurierbar / Fourneaux gaz - brûleurs configurable / Cocinas a gas - quemadores configurable

		3,5 Kw	5,7 Kw	7 Kw	10 Kw
	V. Standard	-	-	2	-
	V. Option	-	1	1	-
	V. Standard	-	1	-	1
	V. Option	-	1	1	-
	V. Standard	-	1	2	1
	V. Option	-	2	2	-
	V. Standard	2	2	-	2
	V. Option	2	2	2	-

La disposizione dei bruciatori è libera, all'interno delle potenze certificate / Free position of burners conform to the certified power output / Die Anordnung der Brenner ist frei, innerhalb der zertifizierten Leistungen / La disposition des brûleurs est libre à l'intérieur des puissances certifiées / La distribución de los quemadores es libre dentro de las potencias certificadas

Contattare ufficio tecnico per fattibilità / Please contact sales department for availability / Für Anfragen wenden Sie sich an unsere Verkaufsabteilung / Adressez vous à notre service vente / Contactar nuestro despacho comercial

Cucine elettriche a induzione / Electric induction ranges / Elektrische Induktionsherde / Electriques induction / Cocinas eléctricas a inducción



	N550PC/IND900 CR1010409	N1100PC/IND450 CR1010389	N1100PC/IND900 CR1010399
Dimensioni esterne External dimensions Außenabmessungen Dim. hors-tout Dimensiones exteriores	cm 90x55x28 h	cm 45x110x28h	cm 90x110x28 h
Tipo di piastra Hot plate type Art der Kochplatte Type de plaque Tipo de placa	2 zone	2 zone	4 zone
N° e potenza piastre Hot plate qty. and power Anz. u. Leistung d. Platten Nombre et puiss. des plaques N° y potencia de placas	kW 2 x 5	kW 2 x 5	kW 4x5
Potenza totale elettrica Total electric power Elektrische Gesamtleistung Puissance totale électrique Potencia total eléctrica	kW 10 ⚡	kW 10 ⚡	kW 20 ⚡
Tensione alimentazione Supply voltage Ansch.-Spann. Tension d'alimentation Tensión de alimentación	400V - 3	400V - 3	400V - 3



	N550PCV/IND900 CR1010419	N550PCVP/IND900 CR1011839	N1100PCV/IND450 CR1010429	N1100PCVP/IND450 CR1011849	N1100PCV/IND900 CR1010439	N1100PCVP/IND900 CR1011859
Dimensioni esterne External dimensions Außenabmessungen Dim. hors-tout Dimensiones exteriores	cm 90x55x86/90h	cm 90x55x86/90h	cm 45x110x86/90h	cm 45x110x86/90h	cm 90x110x86/90h	cm 90x110x86/90h
Tipo di piastra Hot plate type Art der Kochplatte Type de plaque Tipo de placa	2 zone	2 zone	2 zone	2 zone	4 zone	4 zone
Con porte With doors Vec des portes Mit Türen Con puertas	-	2	-	2	-	4
N° e potenza piastre Hot plate qty. and power Anz. u. Leistung d. Platten Nombre et puiss. des plaques N° y potencia de placas	kW 2 x 5	kW 2 x 5	kW 2 x 5	kW 2 x 5	kW 4x5	kW 4x5
Potenza totale elettrica Total electric power Elektrische Gesamtleistung Puissance totale électrique Potencia total eléctrica	kW 10 ⚡	kW 10 ⚡	kW 10 ⚡	kW 10 ⚡	kW 20 ⚡	kW 20 ⚡
Tensione alimentazione Supply voltage Ansch.-Spann. Tension d'alimentation Tensión de alimentación	400V - 3	400V - 3	400V - 3	400V - 3	400V - 3	400V - 3

Cucine elettriche in vitroceramica / Electric ranges with ceramic glass / Elektroherde Glaskeramik / Plaque Electriques vitro ceramique / Cocinas eléctricas vitroceramica

Serie Giano



	N1100PC/VCE450 CR1010449	N1100PC/VCE900 CR1010459
Dimensioni esterne / External dimensions / Außenabmessungen / Dim. hors-tout / Dimensiones exteriores /	cm 45x110x28 h	cm 90x110x28 h
Tipo di piastra / Hot plate type / Art der Kochplatte / Type de plaque / Tipo de placa /	2 27x27cm	4 27x27cm
N° e potenza piastre / Hot plate qty. and power / Anz. u. Leistung d. Platten / Nombre et puiss. des plaques / N° y potencia de placas /	kW 4 x 2	kW 4 x 4
Potenza totale elettrica / Total electric power / Elektrische Gesamtleistung / Puissance totale électrique / Potencia total eléctrica /	kW 8	kW 16
Tensione alimentazione / Supply voltage / Ansch.-Spann. / Tension d'alimentation / Tensión de alimentación /	400V - 3 N	400V - 3 N







	N550PCV/VCE900 CR1011879	N550PCVP/VCE900 CR1011889	N1100PCV/VCE450 CR1010469	N1100PCVP/VCE450 CR1010479	N1100PCV/VCE900 CR1010489	N1100PCVP/VCE900 CR1010499	N1100PCF/VCE900 CR1010509
Dimensioni esterne / External dimensions / Außenabmessungen / Dim. hors-tout / Dimensiones exteriores /	cm 90x55 x86/90h	cm 90x55 x86/90h	cm 45x110 x86/90h	cm 45x110 x86/90h	cm 90x55 x86/90h	cm 90x110 x86/90h	cm 90x110 x86/90cm
Dimensioni interne forni / Oven internal dimensions / Innenabm. der Backöfen / Dim. int. des fours / Dim. interiores hornos /							cm 57.9 x 101.8 x 29.2 h (Grid Dim. 89 x 53.5)
con porte / with doors / vec des portes / mit Türen / con puertas /	-	2	-	2	-	4	-
Tipo di piastra / Hot plate type / Art der Kochplatte / Type de plaque / Tipo de placa /	2 27x27cm	2 27x27cm	2 27x27cm	2 27x27cm	4 27x27cm	4 27x27cm	4 27x27cm
N° e potenza piastre / Hot plate qty. and power / Anz. u. Leistung d. Platten / Nombre et puiss. des plaques / N° y potencia de placas /	kW 4 x 2	kW 4 x 2	kW 4 x 2	kW 4 x 2	kW 4 x 4	kW 4 x 4	kW 4 x 4
Potenza forni elettrici / Electric oven power / Leistung der Elektrobacköfen / Puiss. des fours électriques / Potencia hornos eléctricos /							kW 9
Potenza totale elettrica / Total electric power / Elektrische Gesamtleistung / Puissance totale électrique / Potencia total eléctrica /	kW 8	kW 8	kW 8	kW 8	kW 16	kW 16	kW 25
Tensione alimentazione / Supply voltage / Ansch.-Spann. / Tension d'alimentation / Tensión de alimentación /	400V - 3 N	400V - 3 N	400V - 3 N	400V - 3 N	400V - 3 N	400V - 3 N	400V - 3 N

Tuttapietra / Solid top / Glühplattenherde / Plaque coup-de-feu / Placa radiante





Serie Giano







	N1100TP/900 CR1011099	N1100TPV/900 CR1011109	N1100TPVP/900 CR1011119	N1100TPF/G900 CR1011129	N1100TPF/GE900 CR1011139
Dimensioni esterne / External dimensions / Außenabmessungen / Dim. hors-tout / Dimensiones exteriores /	cm 90x110 x28 h	cm 90x110 x86/90 h	cm 90x110 x86/90 h	cm 90x110 x86/90 h	cm 90x110 x86/90 h
Dimensioni interne forni / Oven internal dimensions / Innenabm. der Backöfen / Dim. int. des fours / Dim. interiores hornos /				cm 53.9x101.8 x29.2 h	cm 53.9x101.8 x29.2 h
Potenza bruciatore piastra / Solid top plate burner output / Leistung des Plattenbrenners / Puissance du brûleur de la plaque / Potencia del quemador de la plancha /	Kw 14	Kw 14	Kw 14	Kw 14	Kw 14
Potenza forno gas / Gas oven power / Leistung des Gas-backofens / Puissance du four à gaz / Potencia del horno a gas /				Kw 11	
Potenza forno elettrico / Electric oven power / Leistung des Elektroherds / Puissance du four électrique / Potencia del horno eléctrico /					kw 9
Potenza totale gas / Total gas power / Gasgesamtleistung / Puissance totale gaz / Potencia total de gas /	14kw Kcal 12040	14kw Kcal 12040	14kw Kcal 12040	25 kw Kcal 21500	14kw Kcal 12040
Potenza totale elettrica / Total electric power / Elektrische Gesamtleistung / Puissance totale électrique / Potencia total eléctrica /					kw 9
Tensione alimentazione / Supply voltage / Ansch.-Spann. / Tension d'alimentation / Tensión de alimentación /					400V - 3 N
Dim. piastra / Griddle plate dim. / Plattenabmessungen / Dim. de la plaque / Dim. de la plancha /	cm 70 x 79.1	cm 70 x 79.1	cm 70 x 79.1	cm 70 x 79.1	cm 70 x 79.1

	N1100TP/E900	N1100TPV/E900	N1100TPVP/E900	N1100TPF/E900
	CR1011149	CR1011159	CR1011169	CR1011179
Dimensioni esterne External dimensions Außenabmessungen Dim. hors-tout Dimensiones exteriores	cm 90x110x28h	cm 90x110x86/90 h	cm 90x110x86/90 h	cm 90x110x86/90 h
con porte with doors vec des portes mit Türen con puertas	-	-	4	-
Potenza resistenza Heating power Beheizungs element Puissance resistences Potencia resistencia	Kw 16	Kw 16	Kw 16	Kw 16
Potenza forno elettrico Electric oven power Leistung des Elektroherds Puissance du four électrique Potencia del horno eléctrico				kW 9
Potenza totale elettrica Total electric power Elektrische Gesamtleistung Puissance totale électrique Potencia total eléctrica	kW 16 ⚡	kW 16 ⚡	kW 16 ⚡	kW 25 ⚡
Tensione alimentazione Supply voltage Ansch.-Spann. Tension d'alimentation Tensión de alimentación	400V - 3 N	400V - 3 N	400V - 3 N	400V - 3 N
Dim. piastra Griddle plate dim. Plattenabmessungen Dim. de la plaque Dim. de la planch	cm 70 x 79.1	cm 70 x 79.1	cm 70 x 79.1	cm 70 x 79.1

	N1100BG/G450	N1100BGV/G450	N1100BGVP/G450
	CR1010249	CR1010259	CR1010269
Dimensioni esterne External dimensions Außenabmessungen Dim. hors-tout Dimensiones exteriores	cm 45x110 x28h	cm 45x110 x86/90h	cm 45x110 x86/90h
Con porte With doors Vec des portes Mit Türen Con puertas	-	-	2
Dimensioni interne vasche Well internal dimensions Beckeninnenabmes-sungen Dim. intérieures cuves Dimensiones interiores de las cubas	cm 34 x 68.7 17.2 h	cm 34 x 68.7 17.2 h	cm 34 x 68.7 17.2 h
Potenza totale gas Total gas power Gasgesamtleistung Puiss. tot. gaz Pot. total de gas	3.6kw Kcal 3095 ⚡	3kw Kcal 3095 ⚡	3kw Kcal 3095 ⚡
Capacità norm. recipiente Tank capacity Kesselkapazität Capacité norm. récipient Capacidad nominal cub	1 x GN 1/3 1 x GN 1/1	1 x GN 1/3 1 x GN 1/1	1 x GN 1/3 1 x GN 1/1

	N1100BG/E450	N1100BGV/E450	N1100BGVP/E450
	CR1010279	CR1010289	CR1010299
Dimensioni esterne / External dimensions / Außenabmessungen / Dim. hors-tout / Dimensiones exteriores	cm 45x110 x28h	cm 45x110 x86/90h	cm 45x110 x86/90h
Con porte / With doors / Vec des portes / Mit Türen / Con puertas	-	-	2
Dimensioni interne vasche / Well internal dimensions / Beckeninnenabmes-sungen / Dim. intérieures cuves / Dimensiones interiores de las cubas	cm 34 x 68.7 17.2 h	cm 34 x 68.7 17.2 h	cm 34 x 68.7 17.2 h
Potenza totale elettrica / Total electric power / Elektrische Gesamtleistung / Puissance totale électrique / Potencia total eléctrica	kW 2.2 ⚡	kW 2.2 ⚡	kW 2.2 ⚡
Tensione alimentazione / Supply voltage / Ansch.-Spann. / Tension d'alimentation / Tensión de alimentación	230V - 1 N	230V - 1 N	400V - 3 N
Capacità norm. recipiente / Tank capacity / Kesselkapazität / Capacité norm. récipient / Capacidad nominal cub /	1 x GN 1/3 1 x GN 1/1	1 x GN 1/3 1 x GN 1/1	1 x GN 1/3 1 x GN 1/1

Brasiera elettrica multiuso / Electric multi cooking bratt pan / Elektro Multi-Bräter / Multi-Sauteuse électrique / Sarten Multiplo eléctrico

Serie Giano

Su vano
On cabinet
Auf unterbau
Sur placard
Sobre base neutra



	N550BRF/E900 CR1010519
Dimensioni esterne / External dimensions / Außenabmessungen Dim. hors-tout / Dimensiones exteriores	cm 90x55 x86/90h
Con porte With doors Vec des portes Mit Türen Con puertas	2
Dimensioni interne vasche / Tank internal dimensions Beckenin-nenabmessungen / Dimensions intérieures cuves Dim. interiores de las cubas	cm 51x30,6 x10,9 h
Capacità vasca / Tank capacity Fassungsvermögen des Beckens Capacité de la cuve / Capacidad de la cuba	l. 21
Potenza totale elettrica / Total electric power Elektrische Gesamtleistung / Puissance totale électrique Potencia total eléctrica	kW 4.5
Tensione alimentazione / Supply voltage / Ansch.-Spann. Tension d'alimentation / Tensión de alimentación	430V - N3

Fry top a gas / Gas griddle plates / Gas-Grillplatten / Grillades gaz / Fry-top gas

Serie Giano

M90x55



	N550FTT/G905 CR1010559	N550FTT/G925 CR1010569	N550FTTV/G905 CR1010579	N550FTTV/G905 CR1010589
Tipo di piastra Griddle plate type Art der Kochplatte Type de plaque Tipo de plancha				
Dim. esterne Ext. dimensions Außenabmessungen Dim. hors-tout Dimensiones exteriores	cm90x55 x28h	cm90x55 x28h	cm90x55 x86/90h	cm90x55 x86/90h
Dim. piastra Griddle plate dim. Plattenabmessungen Dim. de la plaque Dim. de la planch	cm 85X43	cm 85X43	cm 85X43	cm 85X43
Con porte With doors Vec des portes Mit Türen Con puertas	-	-	-	2
Potenza gas Gas power Gasleistung Puissance gaz Potencia de gas	9.5kw Kcal8168 	9.5kw Kcal8168 	9.5kw Kcal8168 	9.5kw Kcal8168

M90x110
Passante/ Pass-through/
Beidseitig / Traversante /
Pasante



	N1100FTT/G905 CR1010649	N1100FTT/G915 CR1010659	N1100FTT/G925 CR1010669	N1100FTTV/G905 CR1010739	N1100FTTV/G905 CR1010749	N1100FTTV/G915 CR1010759	N1100FTTV/G915 CR1010769	N1100FTTV/G925 CR1010779	N1100FTTV/G925 CR1010789
Tipo di piastra Griddle plate type Art der Kochplatte Type de plaque Tipo de plancha									
Dim. esterne Ext. dimensions Außenabmessungen Dim. hors-tout Dimensiones exteriores	cm 90x110 x28h	cm 90x110 x28h	cm 90x110 x86/90h	cm 90x110 x86/90h	cm 90x110 x86/90h	cm 90x110 x86/90h	cm 90x110 x86/90h	cm 90x110 x86/90h	cm 90x110 x86/90h
Dim. piastra Griddle plate dim. Plattenabmessungen Dim. de la plaque Dim. de la planch	cm 90x 76	cm 90x 76	cm 90x 76	cm 90x 76	cm 90x 76	cm 90x 76	cm 90x 76	cm 90x 76	cm 90x 76
Con porte With doors Vec des portes Mit Türen Con puertas	-	-	-	-	4	-	4	-	4
Potenza gas Gas power Gasleistung Puissance gaz Potencia de gas	16kw Kcal13757 	16kw Kcal13757 	16kw Kcal13757 	16kw Kcal13757 	16kw Kcal13757 	16kw Kcal13757 	16kw Kcal13757 	16kw Kcal13757 	16kw Kcal13757

M90x110
Passante/ Pass-through/
Beidseitig / Traversante /
Pasante

EXTRA UE									
	N1100FTT/G900	N1100FTT/G910	N1100FTT/G920	N1100FTTV/G900	N1100FTTV/G910	N1100FTTV/G920	N1100FTVP/G910	N1100FTVP/G920	N1100FTVP/G920
	CR1010619	CR1010629	CR1010639	CR1010679	CR1010689	CR1010699	CR1010709	CR1010719	CR1010729
Tipo di piastra Griddle plate type Art der Kochplatte Type de plaque Tipo de plancha									
Dim. esterne Ext. dimensions Außenabmessungen Dim. hors-tout Dimensiones exteriores	cm 90x110 x28h	cm 90x110 x28h	cm 90x110 x86/90h	cm 90x110 x86/90h	cm 90x110 x86/90h	cm 90x110 x86/90h	cm 90x110 x86/90h	cm 90x110 x86/90h	cm 90x110 x86/90h
Dim. piastra Griddle plate dim. Plattenabmessungen Dim. de la plaque Dim. de la planch	cm 90x 76	cm 90x 76	cm 90x 76	cm 90x 76	cm 90x 76	cm 90x 76	cm 90x 76	cm 90x 76	cm 90x 76
Con porte With doors Vec des portes Mit Türen Con puertas	-	-	-	-	4	-	4	-	4
Potenza gas Gas power Gasleistung Puissance gaz Potencia de gas	16kw Kcal13757 	16kw Kcal13757 	16kw Kcal13757 	16kw Kcal13757 	16kw Kcal13757 	16kw Kcal13757 	16kw Kcal13757 	16kw Kcal13757 	16kw Kcal13757

M90x110
Passante/ Pass-through/
Beidseitig / Traversante /
Pasante

EXTRA UE	
N1100FTT/G900	N1100FTT/G910
CR1010619	CR1010629
Tipo di piastra Griddle plate type Art der Kochplatte Type de plaque Tipo de plancha	
Dim. esterne Ext. dimensions Außenabmessungen Dim. hors-tout Dimensiones exteriores	cm 90x110 x28h
Dim. piastra Griddle plate dim. Plattenabmessungen Dim. de la plaque Dim. de la planch	cm 90x 76
Potenza forno gas Gas oven power Leistung des Gas-backofens Puissance du four à gaz Potencia del horno a gas	11kw Kcal9458
Potenza forno elettrico Electric oven power Leistung des Elektroherds Puissance du four électrique Potencia del horno eléctrico	- kW 9
Potenza totale gas Total gas power Gasgesamtleistung Puiss. tot. gaz Pot. total de gas	27kw Kcal23215
Potenza totale elettrica Total electric power Elektrische Gesamtleistung Puissance totale électrique Potencia total eléctrica	16kw Kcal13757
Tensione alimentazione Supply voltage Ansch.-Spann. Tension d'alimentation Tensión de alimentación	- 400V - 3 N

M90x55

	N550FT/E905	N550FT/E925	N550FTV/E905	N550FTVP/E905
	CR1010849	CR1010859	CR1010869	CR1010879
Tipo di piastra Griddle plate type Art der Kochplatte Type de plaque Tipo de plancha				
Dim. esterne Ext. dimensions Außenabmessungen Dim. hors-tout Dimensiones exteriores	cm90x55 x28h	cm90x55 x28h	cm90x55 x86/90h	cm90x55 x86/90h
Dim. piastra Griddle plate dim. Plattenabmessungen Dim. de la plaque Dim. de la planch	cm 85X43	cm 85X43	cm 85X43	cm 85X43
Con porte With doors Vec des portes Mit Türen Con puertas	-	-	-	2
Potenza totale elettrica Total electric power Elektrische Gesamtleistung Puissance totale électrique Potencia total eléctrica	kW 10 400V 3 N	kW 10 400V 3 N	kW 10 400V 3 N	kW 10 400V 3 N

M90x110
Passante/ Pass-through/
Beidseitig / Traversante /
Pasante

	N1100FT/E905	N1100FT/E925	N1100FTV/E905	N1100FTVP/E905	N1100FTV/E915	N1100FTVP/E915	N1100FTVP/E920	N1100FTVP/E925
	CR1010939	CR1010959	CR1011029	CR1011039	CR1011049	CR1011059	CR1011019	CR1011079
Tipo di piastra Griddle plate type Art der Kochplatte Type de plaque Tipo de plancha								
Dim. esterne Ext. dimensions Außenabmessungen Dim. hors-tout Dimensiones exteriores	cm 90x110 x28h	cm 90x110 x28h	cm 90x110 x86/90h	cm 90x110 x86/90h	cm 90x110 x86/90h	cm 90x110 x86/90h	cm 90x110 x86/90h	cm 90x110 x86/90h
Dim. piastra Griddle plate dim. Plattenabmessungen Dim. de la plaque Dim. de la planch	cm 90x 76	cm 90x 76	cm 90x 76	cm 90x 76	cm 90x 76	cm 90x 76	cm 90x 76	cm 90x 76
Con porte With doors Vec des portes Mit Türen Con puertas	-	-	-	4	-	4	-	4
Potenza totale elettrica Total electric power Elektrische Gesamtleistung Puissance totale électrique Potencia total eléctrica	kW 20 400V 3 N	kW 20 400V 3 N	kW 20 400V 3 N	kW 20 400V 3 N	kW 20 400V 3 N	kW 20 400V 3 N	kW 20 400V 3 N	kW 20 400V 3 N

M90x110
Passante/ Pass-through/
Beidseitig / Traversante/
Pasante



	EXTRA UE								
	N1100FT/E900	N1100FT/E910	N1100FT/E920	N1100FTV/E900	N1100FTVP/E900	N1100FTV/E910	N1100FTVP/E910	N1100FTV/E920	N1100FTVP/E920
	CR1010909	CR1010919	CR1010929	CR1010969	CR1010979	CR1010989	CR1010999	CR1011009	CR1011019
Tipo di piastra Griddle plate type Art der Kochplatte Type de plaque Tipo de plancha									
Dim. esterne Ext. dimensions Außenabmessungen Dim. hors-tout Dimensiones exteriores	cm 90x110 x28h	cm 90x110 x28h	cm 90x110 x86/90h	cm 90x110 x86/90h	cm 90x110 x86/90h	cm 90x110 x86/90h	cm 90x110 x86/90h	cm 90x110 x86/90h	cm 90x110 x86/90h
Dim. piastra Griddle plate dim. Plattenabmessungen Dim. de la plaque Dim. de la plancha	cm 90x 76	cm 90x 76	cm 90x 76	cm 90x 76	cm 90x 76	cm 90x 76	cm 90x 76	cm 90x 76	cm 90x 76
Con porte With doors Vec des portes Mit Türen Con puertas	-	-	-	-	4	-	4	-	-
Potenza totale elettrica Total electric power Elektrische Gesamtleistung Puissance totale électrique Potencia total eléctrica	kW 20 ⚡ 400V 3 N	kW 20 ⚡ 400V 3 N	kW 20 ⚡ 400V 3 N	kW 20 ⚡ 400V 3 N	kW 20 ⚡ 400V 3 N	kW 20 ⚡ 400V 3 N	kW 20 ⚡ 400V 3 N	kW 20 ⚡ 400V 3 N	kW 20 ⚡ 400V 3 N

M90x110
Passante/ Pass-through/
Beidseitig / Traversante/
Pasante



	EXTRA UE
	N1100FTV/E900
	CR1011089
Tipo di piastra Griddle plate type Art der Kochplatte Type de plaque Tipo de plancha	
Dim. esterne Ext. dimensions Außenabmessungen Dim. hors-tout Dimensiones exteriores	cm 90x110 x28h
Dim. piastra Griddle plate dim. Plattenabmessungen Dim. de la plaque Dim. de la plancha	cm 90x 76
Potenza elettrica electric power Elektrische Gesamtleistung Puissance électrique Potencia eléctrica	kW 20 ⚡
Potenza forno elettrico Electric oven power Leistung des Elektroherds Puissance du four électrique Potencia del horno eléctrico	kW 9 ⚡
Potenza totale elettrica Total electric power Elektrische Gesamtleistung Puissance totale électrique Potencia total eléctrica	kW 29 ⚡
Tensione alimentazione Supply voltage Ansch.-Spann. Tensión d'alimentación Tensión de alimentación	400V 3 N



	N550CP/G450	N550CP/G900	N1100CP/G450
	CR1010309	CR1010319	CR0993029
Dimensioni esterne / External dimensions / Außenabmessungen Dim. hors-tout / Dimensiones exteriores	cm 445x55 x86/90h	cm 90x55x 86/90h	cm 45x110 x86/90h
N° vasche / Number of tanks / Anzahl der Becken / Nombre de cuves / N.º de cubas	1	2	1
Dimensioni interne vasche / Tank internal dimensions / Beckeninnenabmessungen / Dimensions intérieures cuves / Dim. interiores de las cubas	cm 30.6 x 34.2 x 30h	cm 30.6 x 34.2 x 30h	cm 30.8 x 51 x 32.7h
Capacità vasca / Tank capacity / Fassungsvermögen des Beckens / Capacité de la cuve / Capacidad de la cuba	l. 26	l.26+26	l. 40
Potenza gas / Gas power / Gasleistung / Puissance gaz / Potencia de gas	kW 13 🔥	kW 26 🔥	kW 14 🔥
Potenza elettrica / Electric power / Elektrische Leistung / Puiss. électrique / Potencia eléctrica			0,1 kw 230V - 1N



	N550CP/E450	N550CP/E900	N1100CP/E450
	CR1010329	CR1010339	CR0993039
Dimensioni esterne / External dimensions / Außenabmessungen Dim. hors-tout / Dimensiones exteriores	cm 445x55 x86/90h	cm 90x55x 86/90h	cm 45x110 x86/90h
N° vasche / Number of tanks / Anzahl der Becken / Nombre de cuves / N.º de cubas	1	2	1
Dimensioni interne vasche / Tank internal dimensions / Beckeninnenabmessungen / Dimensions intérieures cuves / Dim. interiores de las cubas	cm 30.6 x 34.2 x 30h	cm 30.6 x 34.2 x 30h	cm 30.8 x 51 x 32.7h
Capacità vasca / Tank capacity / Fassungsvermögen des Beckens / Capacité de la cuve / Capacidad de la cuba	l. 26	l.26+26	l. 40
Potenza elettrica / Electric power / Elektrische Leistung / Puiss. électrique / Potencia eléctrica	kW 7,5 ⚡	kW 7,5+7,5 ⚡	kW 8,5 ⚡
Tensione alimentazione / Supply voltage / Ansch.-Spann. / Tension d'alimentation / Tensión de alimentación	400V - 3N	400V - 3N	400V - 3N

Friggitrici a gas / Gas deep fat fryers / Gas Friteusen / Friteuses gaz / Freidoras a gas

	N550FR/G450	N550FR/G900	N1100FR/G450
	CR1010349	CR1010359	CR0993009
Dimensioni esterne External dimensions Außenabmessungen Dim. hors-tout Dimensiones exteriores	cm 45x55 x86/90 h	cm 90x55 x86/90 h	cm 45x110 x86/90 h
N° vasche Number of tanks Anzahl der Becken Nombre de cuves N.º de cubas	1	2	1
Capacità vasca Tank capacity Fassungsvermögen des Beckens Capacité de la cuve Capacidad de la cuba	l.10	l.10+10	l. 15
Cestelli in dotazione Baskets equipment Körbe Ausrüstung Paniers equipment Canastos in dotación	n1 15,7x32x12,2 cm)	n2 15,7x32x12,2 cm	n2 22,5x36x130
Potenza gas Gas power Gasleistung Puissance gaz Potencia de gas	kW 9.5 Kcal 8168	kW 19 Kcal 8168	kW 14 Kcal 12038
Potenza elettrica Electric power Elektrische Leistung Puiss. électrique Potencia eléctrica			kW 0.05 230V - 1N

Friggitrici elettriche / Electric deep fat fryers / Elektro Friteusen / Friteuses électriques / Freidoras eléctricas

	N550FR/E450	N550FR/E900	N1100FR/E450
	CR1010369	CR1010379	CR0993019
Dimensioni esterne External dimensions Außenabmessungen Dim. hors-tout Dimensiones exteriores	cm 45x55 x86/90 h	cm 90x55 x86/90 h	cm 45x110 x86/90 h
N° vasche Number of tanks Anzahl der Becken Nombre de cuves N.º de cubas	1	2	1
Capacità vasca Tank capacity Fassungsvermögen des Beckens Capacité de la cuve Capacidad de la cuba	l.10	l.10+10	l. 15
Cestelli in dotazione Baskets equipment Körbe Ausrüstung Paniers equipment Canastos in dotación	n1 15,7x32x12,2 cm)	n2 15,7x32x12,2 cm	n2 22,5x36x130
Potenza elettrica Electric power Elektrische Leistung Puiss. électrique Potencia eléctrica	kW 9 400V - 3N	kW 9+9 400V - 3N	kW 12 400V - 3N

Elementi neutri / Neutral units / Neutralelemente / Elements neutres / Elementos neutros

Top								
	N550NE/450	N550NE/900	N550NEC/450	N550NEC/900	N1100NE/450	N1100NE/900	N1100NEC/450	N1100NEC/900
	CR1010009	CR1010029	CR1010019	CR1010039	CR1010049	CR1010069	CR1010059	CR1010079
Dimensioni esterne External dimensions Außenabmessungen Dim. hors-tout Dim. exteriores	cm 45x55 x28h	cm 90x55 x28h	cm 45x55 x28h	cm 90x55 x28h	cm 45x110 x28h	cm 60x90 x28h	cm 90x110 x28h	cm 90x110 x28h
Cassetti Drawers Schubladen Tiroirs Cajones	-	-	1	2	-	-	2	4
Dimensione interna cassetti Drawer internal dimensions Schubladeninnenabmessungen Dim. int. tiroirs Dim. int. cajones			cm 37.7x 35 13h	cm 37.7x 35 13h			cm 37.7x 35 13h	cm 37.7x 35 13h

Su vano								
On cabinet	N550NEV/450	N550NEV/900	N550NECV/450	N550NECV/900	N1100NEV/450	N1100NEV/900	N1100NECV/450	N1100NECV/900
Auf unterbau	CR1010089	CR1010129	CR1010109	CR1010149	CR1010169	CR1010209	CR1010189	CR1010229
Sur placard								
Sobre base neutra								

	N550NEV/450	N550NEV/900	N550NECV/450	N550NECV/900	N1100NEV/450	N1100NEV/900	N1100NECV/450	N1100NECV/900
	CR1010089	CR1010129	CR1010109	CR1010149	CR1010169	CR1010209	CR1010189	CR1010229
Dimensioni esterne External dimensions Außenabmessungen Dim. hors-tout Dim. exteriores	cm 45x55 x86/90h	cm 90x55 x86/90h	cm 45x55 x86/90h	cm 90x55 x86/90h	cm 45x110 x86/90h	cm 90x110 x86/90h	cm 45x110 x86/90h	cm 90x110 x86/90h
Cassetti Drawers Schubladen Tiroirs Cajones	-	-	1	2	-	-	2	4
Dimensione interna cassetti Drawer internal dimensions Schubladeninnenabmessungen Dim. int. tiroirs Dim. int. cajones			cm 37.7x 35 13h	cm 37.7x 35 13h			cm 37.7x 35 13h	cm 37.7x 35 13h

Su vano								
On cabinet	N550NEVP/450	N550NEVP/900	N550NECV/450	N550NECV/900	N1100NEVP/450	N1100NEVP/900	N1100NECV/450	N1100NECV/900
Auf unterbau	CR1010099	CR1010139	CR1010119	CR1010159	CR1010179	CR1010219	CR1010199	CR1010239
Sur placard								
Sobre base neutra								

	N550NEVP/450	N550NEVP/900	N550NECV/450	N550NECV/900	N1100NEVP/450	N1100NEVP/900	N1100NECV/450	N1100NECV/900
	CR1010099	CR1010139	CR1010119	CR1010159	CR1010179	CR1010219	CR1010199	CR1010239
Dimensioni esterne External dimensions Außenabmessungen Dim. hors-tout Dim. exteriores	cm 45x55 x86/90h	cm 90x55 x86/90h	cm 45x55 x86/90h	cm 90x55 x86/90h	cm 45x110 x86/90h	cm 90x110 x86/90h	cm 45x110 x86/90h	cm 90x110 x86/90h
Con porte With doors Vec des portes Mit Türen Con puertas	1	2	1	2	2	4	2	4



Serie 600



TECHNICAL DATA







						
	6NPC/G411	6NPC/G722	6NPC/GF722	6NPC/GFE722	6NPC/GFEV722	6NPC/GF1122
	CR0855669	CR0855679	CR0855699	CR0855709	CR0855719	CR0855729
Dimensioni esterne External dimensions Außenabmessungen Dim. hors-tout Dimensiones exteriores	cm 40x65x 29.5/49h	cm 70x65x 29.5/49h	cm 70x65x 87/106.5h	cm 70x65x 87/106.5h	cm 70x65x 87/106.5h	cm 1100x65x 87/106.5h
Bruciatori a gas (versione base) Gas burners (basic configuration) Gasbrenner (Grundausrüstung) Brûleurs gaz (version de base) Quemadores a gas (versión normal)	kW 1x 3,5 1x5,5	kW 2x 3,5 2x5,5	kW 2x 3,5 2x5,5	kW 2x 3,5 2x5,5	kW 2x 3,5 2x5,5	kW 3x 3,5 3x5,5
Dimensioni interne forni Oven internal dimensions Innenabm. der Backöfen Dim. int. des fours Dim. interiores hornos	-	-	cm 57 x 53 x 29h (Grid Dim. 53x49)	cm 57 x 53 x 29h (Grid Dim. 53x49)	cm 57 x 53 x 29h (Grid Dim. 53x49)	cm 57 x 53 x 29h (Grid Dim. 53x49)
Potenza forni a gas Gas oven power Leistung der Gasbacköfen Puissance des fours à gaz Pot. de hornos a gas			5kw 			5kw 
Potenza forni elettrici Electric oven power Leistung der E-Backöfen Puissance des fours électr. Pot. hornos eléc.				4.2 kW 	4.2 kW  Ventilato / airy Heißluftofen ventilè / ventilado	
Potenza totale gas Total gas power Gasgesamtleistung Puissance totale gaz Potencia total de gas	9 kw Kcal 7738 	18 kw Kcal 15477 	23k w Kcal 19776 	18 kw Kcal 15477 	18 kw Kcal 15477 	32kw Kcal 27515 
Potenza totale elettrica Total electric power Elektrische Gesamtleistung Puissance totale électrique Potencia total eléctrica				4.2 kW 	4.2 kW 	5 kW 
Tensione alimentazione Supply voltage Ansch.-Spann. Tension d'alimentation Tensión de alimentación				400V - 3 N	400V - 3 N	400V - 3 N











	6NPC/E400	6NPC/E400P	6NPC/E700	6NPC/E700P	6NPC/EFE700	6NPC/EFE700P	6NPC/EFEV700	6NPC/EFEV700P
	CR0855739	CR0855749	CR0855759	CR0855769	CR0855779	CR0855789	CR0855799	CR0855809
Dimensioni esterne / External dimensions / Außenabmessungen / Dim. hors-tout / Dimensiones exteriores /	cm 40 x 60 x29.5 h	cm 40 x 60 x29.5 h	cm 70 x 60 x29.5 h	cm 70 x 60 x29.5 h	cm 70 x 65 x87/106.5 h	cm 70 x 65 x87/106.5 h	cm 70 x 65 x87/106.5 h	cm 70 x 65 x87/106.5 h
Dimensioni interne forni / Oven internal dimensions / Innenabm. der Backöfen / Dim. int. des fours / Dim. interiores hornos /					cm 57 x 53 x 29h (Grid Dim. 53x49)	cm 57 x 53 x 29h (Grid Dim. 53x49)	cm 57 x 53 x 29h (Grid Dim. 53x49)	cm 57 x 53 x 29h (Grid Dim. 53x49)
Tipo di piastra / Hot plate type / Art der Kochplatte / Type de plaque / Tipo de placa /	2 1xØ18cm 1xØ22cm	2 2x Ø22cm	4 2xØ18cm 2xØ22cm	4 4xØ22cm	4 2xØ18cm 2xØ22cm	4 4xØ22cm	4 2xØ18cm 2xØ22cm	4 4xØ22cm
N° e potenza piastre / Hot plate qty. and power / Anz. u. Leistung d. Platten / Nombre et puiss. des plaques / N° y potencia de placas /	kW 1x1.5 1x2.6	kW 2x2.6	kW 2x1.5 2x2.6	kW 4x2.6	kW 2x1.5 2x2.6	kW 4x2.6	kW 2x1.5 2x2.6	kW 4x2.6
Potenza forni elettrici / Electric oven power / Leistung der Elektrobacköfen / Puiss. des fours électriques / Potencia hornos eléctricos /	-	-	-	-	kW 4.2	kW 4.2	kW 4.2 Ventilato / airy Heißluftofen ventilé / ventilado	kW 4.2 Ventilato / airy Heißluftofen ventilé / ventilado
Potenza totale elettrica / Total electric power / Elektrische Gesamtleistung / Puissance totale électrique / Potencia total eléctrica /	kW 4.1 	kW 5.2 	kW 8.2 	kW 10.4 	kW 12.4 	kW 14.6 	kW 12.4 	kW 14.6
Tensione alimentazione / Supply voltage / Ansch.-Spann. / Tension d'alimentation / Tensión de alimentación /	400V - 3 N	400V - 3 N	400V - 3 N	400V - 3 N	400V - 3 N	400V - 3 N	400V - 3 N	400V - 3 N







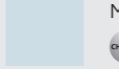
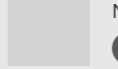

	6NPC/I411	6NPC/I411P	6NPC/I722	6NPC/I722P	6NPC/IFEV722	6NPC/IFEV722P
	CR0855819	CR0855829	CR0855839	CR0855849	CR0855859	CR0855869
Dimensioni esterne / External dimensions / Außenabmessungen / Dim. hors-tout / Dimensiones exteriores /	cm 40 x 60 x 29.5 h	cm 40 x 60 x 29.5 h	cm 70 x 60 x 29.5 h	cm 70 x 60 x 29.5 h	cm 70 x 60 x 87/106.5 h	cm 70 x 60 x 87/106.5 h
Dimensioni interne forni / Oven internal dimensions / Innenabm. der Backöfen / Dim. int. des fours / Dim. interiores hornos /					cm 57 x 53 x 29h (Grid Dim. 53x49)	cm 57 x 53 x 29h (Grid Dim. 53x49)
Tipo di piastra / Hot plate type / Art der Kochplatte / Type de plaque / Tipo de placa /	2 1xØ22cm 1xØ18cm	2 2xØ22cm	4 2xØ22cm 1xØ18cm 1xØ14.5cm	4 4xØ22cm	4 2xØ22cm 1xØ18cm 1xØ14.5cm	4 4xØ22cm
N° e potenza piastre / Hot plate qty. and power / Anz. u. Leistung d. Platten / Nombre et puiss. des plaques / N° y potencia de placas /	kW 1 x 2.5 1 x 1.8	kW 2 x 2.5	kW 2 x 2.5 1 x 1.8 1 x 1.2	kW 4 x 2.5	kW 2 x 2.5 1 x 1.8 1 x 1.2	kW 4 x 2.5
Potenza forni elettrici / Electric oven power / Leistung der Elektrobacköfen / Puiss. des fours électriques / Potencia hornos eléctricos /					kW 4.2 Ventilato / airy Heißluftofen ventilé / ventilado	kW 4.2 Ventilato / airy Heißluftofen ventilé / ventilado
Potenza totale elettrica / Total electric power / Elektrische Gesamtleistung / Puissance totale électrique / Potencia total eléctrica /	kW 4.3 	kW 5 	kW 8 	kW 10 	kW 12.2 	kW 14.2
Tensione alimentazione / Supply voltage / Ansch.-Spann. / Tension d'alimentation / Tensión de alimentación /	400V - 3 N	400V - 3 N	400V - 3 N	400V - 3 N	400V - 3 N	400V - 3 N

			
	6NPC/IND411 CR0855879	6NPC/IND722 CR0855889	6NPC/WOK411 CR0856259
Dimensioni esterne External dimensions Außenabmessungen Dim. hors-tout Dimensiones exteriores	cm 40x65 x29,5/49h	cm 70x65 x29,5/49h	cm 40x65 x29,5/49 h
Tipo di piastra Hot plate type Art der Kochplatte Type de plaque Tipo de placa	 1 Ø22cm	 2 Ø22cm	 1 Ø30cm
N° e potenza piastre Hot plate qty. and power Anz. u. Leistung d. Platten Nombre et puiss. des plaques Nº y potencia de placas	kW 1 x 5	kW 2 x 5	kW 1x5
Potenza totale elettrica Total electric power Elektrische Gesamtleistung Puissance totale électrique Potencia total eléctrica	kW 5	kW 10	kW 5
Tensione alimentazione Supply voltage Ansch.-Spann. Tension d'alimentation Tensión de alimentación	400V - 3	400V - 3	400V - 3

			
	6NFT/G400C CR0855909	EXTRA UE 6NFT/G400L CR0855899	
Tipo di piastra Hot plate type Art der Kochplatte Type de plaque Tipo de placa	 M 40 CHROME	 M 40 FE	
Dim. piastra Griddle plate dim. Plattenabmessungen Dim. de la plaque Dim. de la planch	cm 39.6 x 55.5	cm 39.6 x 55.5	
Potenza gas Gas power Gasleistung Puissance gaz Potencia de gas	5kw Kcal4299	5kw Kcal4299	

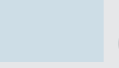
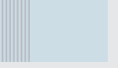
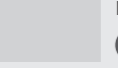
			
	6NFT/G600LC CR0855939	EXTRA UE 6NFT/G600L CR0855919	
Tipo di piastra Hot plate type Art der Kochplatte Type de plaque Tipo de placa	 M 60 CHROME	 M 60 FE	 M 60 FE
Dim. piastra Griddle plate dim. Plattenabmessungen Dim. de la plaque Dim. de la planch	cm 59.6 x 55.5	cm 59.6 x 55.5	cm 59.6 x 55.5
Potenza gas Gas power Gasleistung Puissance gaz Potencia de gas	10kw Kcal 8598	10kw Kcal 8598	10kw Kcal 8598

				
	6NFT/G800LC CR0855949	6NFT/G800LRC CR0855959	EXTRA UE 6NFT/G800L CR0855489	
Tipo di piastra Hot plate type Art der Kochplatte Type de plaque Tipo de placa	 M 80 CHROME	 M 80 CHROME	 M 80 FE	 M 80 FE
Dim. piastra Griddle plate dim. Plattenabmessungen Dim. de la plaque Dim. de la planch	cm 79.6 x 55.5	cm 79.6 x 55.5	cm 79.6 x 55.5	cm 79.6 x 55.5
Potenza gas Gas power Gasleistung Puissance gaz Potencia de gas	12.5 kw Kcal 10748	12.5 kw Kcal 10748	12.5 kw Kcal 10748	12.5 kw Kcal 10748

M 40
cm 40x60x29.5/49



	EXTRA UE	
	6NFT/E400LC	6NFT/E400L
	CR0855989	CR0855969
Tipo di piastra Hot plate type Art der Kochplatte Type de plaque Tipo de placa	M 40 CHROME	M 40 FE
Dim. piastra Griddle plate dim. Plattenabmessungen Dim. de la plaque Dim. de la planch	cm 39.6 x 55.5	cm 39.6 x 55.5
Potenza gas Gas power Gasleistung Puissance gaz Potencia de gas	3.9kw Ac400V-3N ⚡	7.8Kw Ac400V-3N ⚡

M 60
cm 60x65x29.5/49



	EXTRA UE		
	6NFT/E600LC	6NFT/E600L	6NFT/E600LR
	CR0856019	CR0855999	CR0856009
Tipo di piastra Hot plate type Art der Kochplatte Type de plaque Tipo de placa	M 60 CHROME	M 60 FE	M 60 FE
Dim. piastra Griddle plate dim. Plattenabmessungen Dim. de la plaque Dim. de la planch	cm 59.6 x 55.5	cm 59.6 x 55.5	cm 59.6 x 55.5
Potenza gas Gas power Gasleistung Puissance gaz Potencia de gas	3.9kw Ac400V-3N ⚡	7.8Kw Ac400V-3N ⚡	11.7kw Ac400V-3N ⚡

M 100
cm 100x60x29.5/49



	EXTRA UE		
	6NFT/E1000LC	6NFT/E1000L	6NFT/E1000LR
	CR0855499	CR0856029	CR0856039
Tipo di piastra Hot plate type Art der Kochplatte Type de plaque Tipo de placa	M 100 CHROME	M 100 FE	M 100 FE
Dim. piastra Griddle plate dim. Plattenabmessungen Dim. de la plaque Dim. de la planch	cm 99.6 x 55.5	cm 99.6 x 55.5	cm 99.6 x 55.5
Potenza gas Gas power Gasleistung Puissance gaz Potencia de gas	11.7kw Ac400V-3N ⚡	11.7Kw Ac400V-3N ⚡	11.7kw Ac400V-3N ⚡



	6NFR/G400	6NFR/G600
	CR0856089	CR0856099
Dimensioni esterne / External dimensions / Außenabmessungen / Dim. hors-tout / Dimensiones exteriores	cm 40 x 65 x29.5/49h	cm 60 x 65 x29.5/49h
N° vasche / Number of tanks / Anzahl der Becken / Nombre de cuves / N.º de cubas	1	2
Dimensioni interne vasche / Tank internal dimensions / Beckeninnenabmessungen / Dimensions intérieures cuves / Dim. interiores de las cubas	cm 24 x 42	cm 24 x 42
Capacità vasca / Tank capacity / Fassungsvermögen des Beckens / Capacité de la cuve / Capacidad de la cuba	l.8	l.8+8
Cestelli in dotazione / Baskets equipment / Körbe Ausrüstung / Paniers equipment / Canastos in dotación	n.1 10X28X11.5	n.2 10X28X11.5
Potenza gas / Gas power / Gasleistung / Puissance gaz / Potencia de gas	kW 7 ⚡ Kcal 6020	kW 14 ⚡ Kcal12040



	6NFR/E400R	6NFR/E400PR	6NFR/E600R	6NFR/E600PR
	CR0856109	CR0856129	CR0856119	CR0856139
Dimensioni esterne External dimensions Außenabmessungen Dim. hors-tout Dimensiones exteriores	cm 40 x 65 x29.5h	cm 40 x 65 x29.5h	cm 60 x 65 x29.5h	cm 60 x 65 x29.5h
N° vasche Number of tanks Anzahl der Becken Nombre de cuves N.º de cubas	1	1	1	2
Dimensioni interne vasche / Tank internal dimensions / Beckeninnenabmessungen / Dimensions intérieures cuves / Dim. interiores de las cubas	cm 22 x 34	cm 22 x 34	cm 22 x 34	cm 22 x 34
Capacità vasca Tank capacity Fassungsvermögen des Beckens Capacité de la cuve Capacidad de la cuba	l.10	l.10	l. 10+10	l.10+10
Cestelli in dotazione Baskets equipment Körbe Ausrüstung Paniers equipment Canastos in dotación	n1 17.5X30X10.5	n1 17.5X30X10.5	n2 17.5X30X10.5	n2 17.5X30X10.5
Potenza elettrica Electric power Elektrische Leistung Puiss. électrique Potencia eléctrica	kW 6 ⚡ 400V - 3N	kW 9 ⚡ 400V - 3N	kW 12 ⚡ 400V - 3N	kW 18 ⚡ 400V - 3N

Contenitore caldo elettrico / Electric chip scuttle / Elektrowarmhaltegerät / Récipient chaud électrique / Recipiente caliente eléctrico

Serie 600



	6NSP/E400 CR0856219
Capacità/ Capacity / Kapazität / Capacité/ Capacidad	GN1/1
Dimensioni esterne / External dimensions / Außenabmessungen / Dim. hors-tout / Dimensiones exteriores	cm 40 x 60 29.5h
Regolazione temperatura / temperature adjustment / Temperatureinstellung / ajustement de la température / ajuste de temperatura	30° - 90°
Potenza totale elettrica / Total electric power / Elektrische Gesamtleistung / Puiss. tot. électrique / Potencia total eléctrica	kW 2 ⚡
Tensione alimentazione / Supply voltage / Ansch.-Spann. / Tension d'alimentation / Tensión de alimentación	230V - 1 N

Brasiera elettrica multiuso / Electric multi cooking bratt pan / Elektro Multi-Bräter / Multi-Sauteuse électrique / Sarten Multiplo eléctrico

Su vano
On cabinet
Auf unterbau
Sur placard
Sobre base neutra



	6NBF/E400 CR0856179	6NBF/E600 CR0856179
Dimensioni esterne / External dimensions / Außenabmessungen / Dim. hors-tout / Dimensiones exteriores	cm 40 x 60 87 h	cm 60 x 60 87 h
Dimensioni interne vasche / Tank internal dimensions / Beckenin-nenabmessungen / Dimensions intérieures cuves / Dim. interiores de las cubas	cm 32 x 48 x 9.2 h	cm 52 x 48 x 9.2 h
Capacità vasca / Tank capacity / Fassungsvermögen des Beckens / Capacité de la cuve / Capacidad de la cuba	l. 13	l. 21
N. zone di cottura / N. of cooking zones / Anzahl der Kochzonen / N. de zones de cuisson / N. de zonas de cocción	1	2
Potenza totale elettrica / Total electric power / Elektrische Gesamtleistung / Puissance totale électrique / Potencia total eléctrica	kW 4.05 ⚡	kW 8.1 ⚡
Tensione alimentazione / Supply voltage / Ansch.-Spann. / Tension d'alimentation / Tensión de alimentación	400V - 3 N	400V - 3 N

Bagnomaria elettrici / electric bain maries / elektro Wasserbäder / Bain-marie électrique / Baño maria eléctrico

Serie 600



	6NBM/E400 CR0856189	6NBM/E600 CR0856199	6NBM/E800 CR0856209
Dimensioni esterne / External dimensions / Außenabmessungen / Dim. hors-tout / Dimensiones exteriores	cm 40x60x29,5h	cm 60x60x29,5h	cm 80x60x29,5h
Dimensioni interne vasche / Well internal dimensions / Beckenin-nenabmessungen / Dim. intérieures cuves / Dimensiones interiores de las cubas	cm 32.5 x 53 x 20	cm 48.7 x 53 x 20	cm 65 x 53 x 20
Potenza totale elettrica / Total electric power / Elektrische Gesamtleistung / Puissance totale électrique / Potencia total eléctrica	kW 1 ⚡	kW 1,8 ⚡	kW 2 ⚡
Tensione alimentazione / Supply voltage / Ansch.-Spann. / Tension d'alimentation / Tensión de alimentación	230V - 1 N	230V - 1 N	230V - 1 N
Capacità norm. recipiente / Tank capacity / Kesselkapazität / Capacité norm. récipient / Capacidad nominal cub	1 x GN 1/1	1 x GN 1/1 2 x GN 1/4	2 x GN 1/1

Cuocipasta elettrici / Electric pasta-cooker / Elektronudelkocher / Cuisièrs à pâte électriques / Cuecepastas eléctricos



	6NCP/E400 CR0856149	6NCP/E600 CR0856159
Dimensioni esterne / External dimensions / Außenabmessungen / Dim. hors-tout / Dimensiones exteriores	cm 40x60 x29,5 h	cm 60x60 x29,5 h
N. vasche / N. Tank / Anzahl der Tanks / N. cuves / N. cubas	1	1
Dimensioni interne vasche / Tank internal dimensions / Beckenin-nenabmessungen / Dimensions intérieures cuves / Dim. interiores de las cubas	cm 30.8 x 34 x 18h	cm 49 x 34 x 18h
Capacità vasca / Tank capacity / Fassungsvermögen des Beckens / Capacité de la cuve / Capacidad de la cuba	l.20	l. 28
Potenza elettrica / Electric power / Elektrische Leistung / Puiss. électrique / Potencia eléctrica	kW 5.67 ⚡	kW 9 ⚡
Tensione alimentazione / Supply voltage / Ansch.-Spann. / Tension d'alimentation / Tensión de alimentación	400V - 3N	400V - 3N

Contact grill / Contact grill / Contact grill / Contact grill / Contact grill /









	6NCW/E400 CR0856069	6NCW/E800 CR0856079
Dimensioni esterne External dimensions Außenabmessungen Dim. hors-tout Dimensiones exteriores	cm 40x60 x29.5h	cm 60x60 x29.5h
Dimensioni griglia Grill rack dimensions Grillfläche Abm. Dim. de la grille Dim. parilla	cm 27 x 43	cm 36 x 43
Superficie griglia Grill rack surface Grillfläche Ober. Sup. grille Sup. parilla	m2 0,12	m2 0,16
Potenza totale elettrica Total electric power Elektrische Gesamtleistung Puissance totale électrique Potencia total eléctrica	kW 4.08 ⚡ 400V - 3N	kW 5.44 ⚡ 400V - 3N

Griglie a pietra lavica / Lava rock grills / Lavasteingrills / Grilles à pierre volcanique /
Barbacoa de piedra lávica



	6NGL/G400	6NGL/G800
Dimensioni esterne External dimensions Außenabmessungen Dim. hors-tout Dimensiones exteriores	cm 40x60 x29.5h	cm 60x60 x29.5h
Dimensioni griglia Grill rack dimensions Grillfläche Abm. Dim. de la grille Dim. parilla	cm 37 x 51.5	cm 66 X51.5
Superficie griglia Grill rack surface Grillfläche Ober. Sup. grille Sup. parilla	m2 0,19	m2 0,34
Potenza gas / Gas power / Gasleistung / Puissance gaz / Potencia de gas	kW 7 🔥	kW 14 🔥

Elementi neutri / Neutral units / Neutralelemente / Elements neutres / Elementos neutros

						
	6NE/100	6NE/400	6NE/400	6NEC/400	6NEC/600	6NLA/600
	CR0855649	CR0855599	CR0855599	CR0855609	CR0855629	CR0855639
Dimensioni esterne External dimensions Außenabmessungen Dim. hors-tout Dim. exteriores	10x60x29,5	40x60x29,5	60x60x29,5	40x60x29,5	60x60x29,5	60x60x29,5
Cassetti Drawers Schubladen Tiroirs Cajones	-	-	-	1	1	-
Dimensione interna cassetti Drawer internal dimensions Schubladeninnenabmessungen Dim. int. tiroirs Dim. int. cajones				cm 30,5 x 53,5 10,5 h	cm 30,5 x 53,5 10,5 h	
Con rubinetto With tap Mit tippen Avec robinet Con grifo	-	-	-	-	-	●
Dimensioni interne vasche Tank internal dimensions Beckeninnenabmessungen Dimensions intérieures cuves Dim. interiores de las cubas						cm 50x40x15

Le immagini sono puramente indicative. I dati riportati sul presente documento sono da ritenersi non vincolanti.
L'azienda si riserva di apportare modifiche tecniche in qualsiasi momento.

Images are indicative only. The specifications shown in this document are to be considered not binding.
The company reserves the right to make technical changes at any moment.

Abbildung ähnlich. Die auf dieser Unterlage angegebenen technischen Daten sind als unverbindlich anzusehen.
Die Firma behält sich das Recht vor zu jeder Zeit technische Änderungen vorzunehmen.

Ces Images sont à titre indicatif. Les données techniques sur ce document ne doivent pas être considérées contraignantes.
La société se réserve le droit d'apporter des modifications techniques à tout moment.

Estas imágenes son meramente indicativas. Los datos mostrados en este documento se deben considerar no vinculantes.
La empresa se reserva el derecho de realizar cambios en cualquier momento sin previo aviso.



EVERYDAY *Choices*



www.baronprofessional.com



Grupo Roig

Polígono Industrial A Tomada, n 61
15940 A Pobra do Caramiñal
(A Coruña)

☎ [981 831 321](tel:981831321)

✉ gruporoig@gruporoig.es

@gruporoig

