



BUFFET

50TH
1974
2024

Overview 2024



Overview

2024



50TH
1974
2024

50 YEARS OF PASSION

1974 - 2024

Cosa significa mettersi in gioco? La risposta è nell'orgoglio di poter celebrare il traguardo del mezzo secolo di attività. Dal 1974 una piccola impresa artigianale ha saputo costruirsi, reinventarsi e rinnovarsi fino ad arrivare ai giorni d'oggi in cui possiamo affermare con fierezza di essere un player di riferimento nel mercato mondiale dell'HO.RE.CA.

Il nostro lavoro ogni giorno celebra ed evolve lo spirito imprenditoriale che ha fondato questa azienda. In Rocam non vediamo il mezzo secolo come un traguardo ma come un nuovo trampolino di partenza per essere sempre più competitivi e all'avanguardia. Con passione e dedizione creiamo eccellenza per dare valore ai vostri progetti.

What does it mean to get involved? The answer lies in the pride of being able to celebrate the milestone of half a century of activity. Since 1974, a small artisanal business has been able to build, reinvent and renew itself until today, where we can proudly say that we are a key player in the global HO.RE.CA market.

Our everyday work celebrates and evolves the entrepreneurial spirit that founded this company. At Rocam, we don't see half a century as a finish line but as a new starting point to become even more competitive and innovative. With passion and dedication, we create excellence to add value to your projects.



1974

1979

1986

1996

2003

2014 ...



ITALIAN STYLE

*100% Designed
and handcrafted in Italy*

I nostri prodotti sono realizzati con le tecnologie e i materiali più avanzati ma conservano il fascino di una lavorazione artigianale. Ogni articolo è frutto di un'accurata progettazione che unisce l'innovazione a funzionalità e design. Inoltre, ogni articolo è sottoposto a severi controlli e può essere personalizzato da un'ampia gamma di colorazioni per il legno. Il risultato è un oggetto unico e di alto livello, dallo stile inconfondibilmente italiano.

Our products are made with the most advanced technologies and materials, but they retain the charm of a handcrafted process. Each item is the result of an accurate project which combines innovation with functionality and design. Furthermore, each item is subjected to strict controls and can be customized with a wide range of wood colors. The result is a unique, high-level object with an unmistakably Italian style.

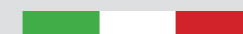
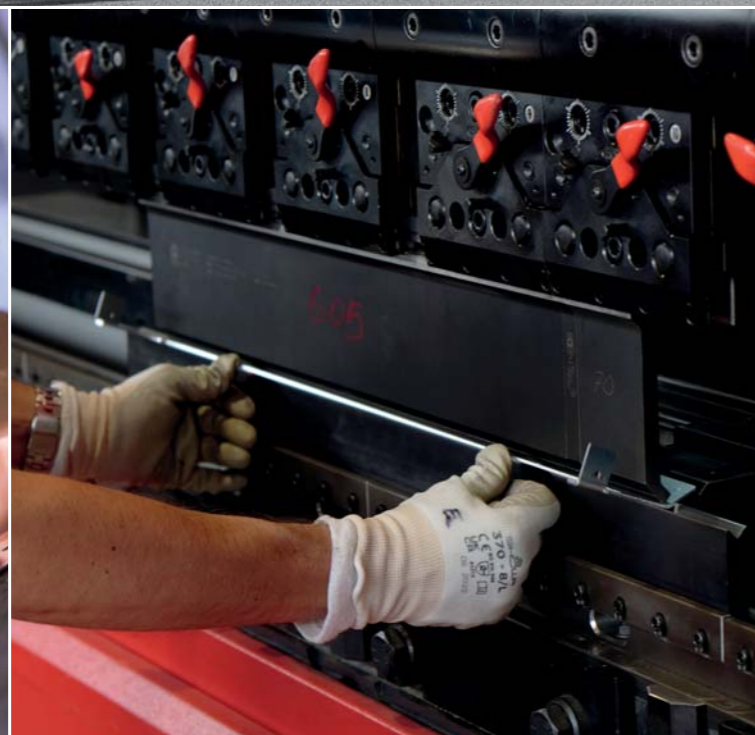

MADE IN ITALY

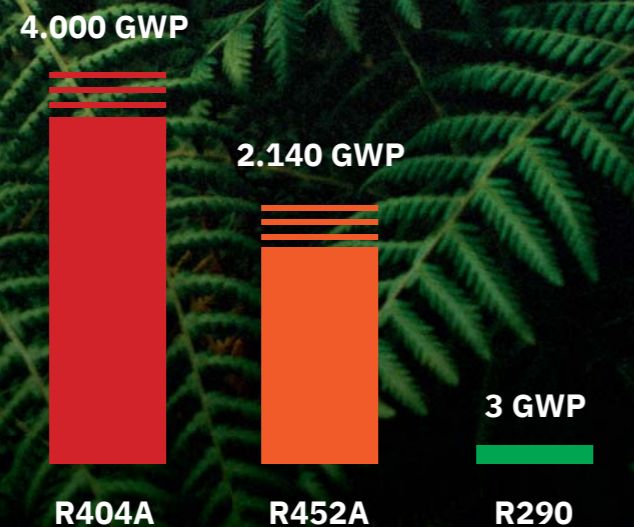

GWP / Global warming potential index - CO² = 1

NATURAL REFRIGERANT

European Regulation F-Gas 517/2014

Il Regolamento Europeo 517/2014 impone una drastica riduzione nell'emissione di gas a effetto serra, con un target di riduzione del 79% entro il 2030.

Perché l'R290?

Le proprietà termodinamiche dell'R290 sono superiori a R134a, a R452a sia a R404a. La capacità termica del refrigerante R290 è circa il 90% maggiore del R134a e il 140% maggiore del R404a con minore viscosità. Ciò significa che l'R290 può assorbire più calore, più velocemente, con un recupero più rapido della temperatura e un minore consumo di energia.

Il refrigerante R290, un refrigerante idrocarburo (HC) è un propano altamente raffinato che rappresenta un'alternativa sicura ed ecologica ai refrigeranti a idrofluorocarburi (HFC).

Cosa sono i refrigeranti idrocarburi (HC)?

Sono refrigeranti naturali non tossici che non hanno impatto sulla riduzione dell'ozono e sono a basso potenziale di riscaldamento globale. Gli idrocarburi sono tra i refrigeranti più eco-compatibili e convenienti per raffreddare e congelare. Gli attuali refrigeranti HFC (R134a, R452a e R404a) hanno un potenziale di riscaldamento globale estremamente elevato (GWP) e dannoso per l'ambiente.

Il GWP esprime il contributo all'effetto serra di un gas serra in confronto al CO₂, il cui potenziale di riferimento è 1. Più basso è il GWP, migliore è la sostanza per l'ambiente. In confronto agli altri gas, l'idrocarburo R290 ha un GWP minimo pari a soli 3 punti. L'R290, insomma, appartiene alle migliori alternative verdi ai comuni refrigeranti utilizzati nell'industria.

The European Regulation 517/2014 requires a drastic reduction in greenhouse gas emissions, with a reduction target of 79% by 2030.

Why R290?

The thermodynamic properties of R290 are superior to R134a, R452a and R404a. The heat capacity of R290 refrigerant is approx. 90% greater than R134a and 140% greater than R404a with lower viscosity. This means that the R290 can absorb more heat, faster, with faster temperature recovery and lower power consumption.

R290 refrigerant, a hydrocarbon (HC) refrigerant is a highly refined propane that is a safe and environmentally friendly alternative to hydrofluorocarbon (HFC) refrigerants.

What are hydrocarbon (HC) refrigerants?

They are natural, non-toxic refrigerants that have no impact on ozone depletion and have a low global warming potential. Hydrocarbons are among the most eco-friendly and convenient refrigerants for cooling and freezing. The current HFC refrigerants (R134a, R452a and R404a) have an extremely high global warming potential (GWP) and harmful to the environment.

The GWP expresses the contribution to the greenhouse effect of a greenhouse gas compared to CO₂, whose reference potential is 1. The lower the GWP, the better the substance for the environment. Compared to other gases, R290 hydrocarbon has a minimum GWP of only 3 points. In short, R290 belongs to the best green alternatives to common refrigerants used in industry.



CO-DESIGN & ARCHITECTURAL LAYOUT

Your ideas, our experience

Rocam mette a vostra disposizione un servizio di consulenza e progettazione personalizzato per soddisfare qualsiasi vostra esigenza. Studiamo e sviluppiamo insieme a voi le migliori soluzioni per il layout e la disposizione di sale mensa, ristoranti e self service a partire dal vostro progetto.

Rocam offers you a customized consulting and planning service to meet your every needs. We study and develop with you the best solutions for the layout and arrangement of dining rooms, restaurants and self-service lines starting from your project.

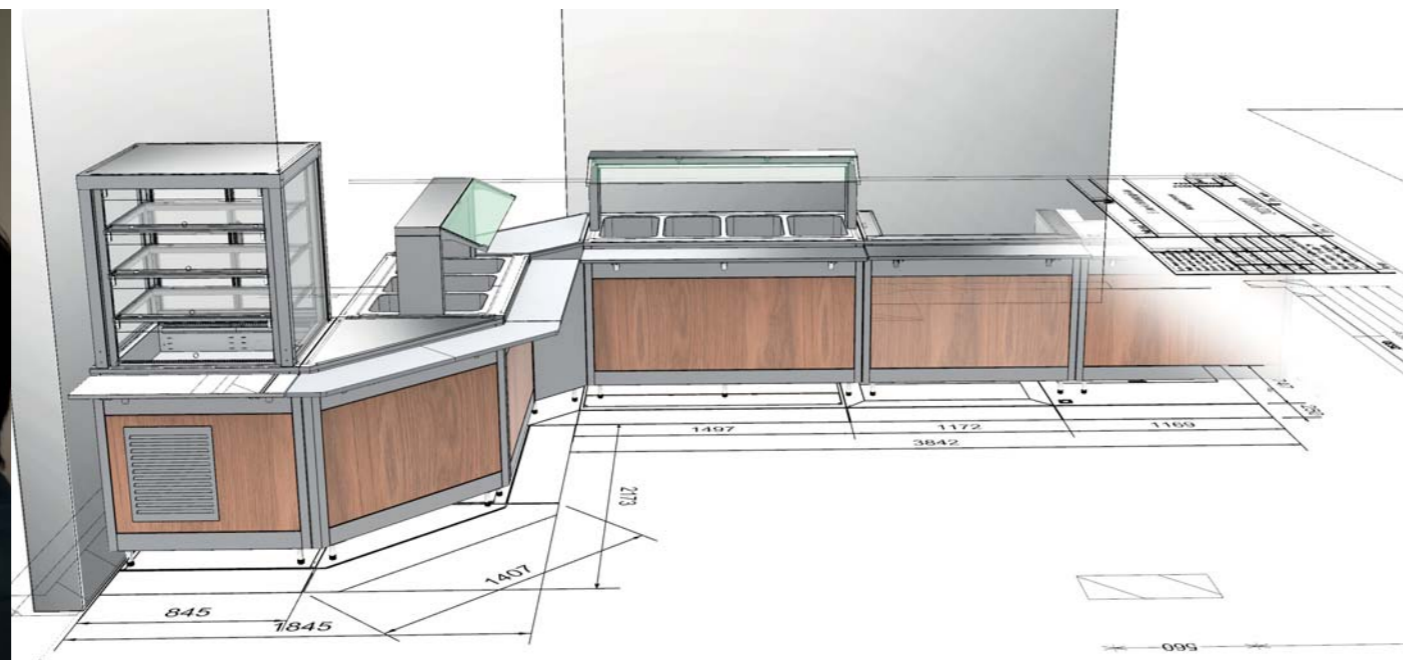

WE MAKE YOUR LAYOUT



SMART SOLUTIONS FOR FOODSERVICE

Your needs, our creativity

Come nasce un'opera d'arte? Dando forma all'intuizione creativa. Con una scelta oculata delle materie prime, una progettazione lungimirante, un'estrema attenzione al dettaglio e il supporto dell'innovazione tecnologica. È con questi presupposti che abbiamo realizzato la nuova gamma di prodotti Rocam. Non semplici attrezzature foodservice ma soluzioni brillanti che rispondono alle attuali esigenze del Mercato, degli strumenti che trasformano la tua creatività culinaria in un capolavoro.

How does a work of art come to light? Shaping creative intuition with a careful choice of raw materials, a farsighted design, extreme attention to detail and the support of technological innovation. With these assumptions we have created the new Rocam product range. Not just foodservice equipments, but smart solutions that respond to the current needs of the Market and equipments that transform the culinary creativity into a masterpiece.

Products Range

SELF SERVICE

The best service

La nostra gamma di moduli self-service si è arricchita di nuove linee e innovative soluzioni con proposte capaci di soddisfare le più svariate esigenze estetiche ma soprattutto capaci di offrire destinazioni d'uso completamente differenti tra di loro, dai moduli DROP-IN, studiati per potersi adattare a qualunque soluzione su misura, alle linee OMNIA e ATHENA, perfette per arredare linee self service all'interno di mense aziendali o scolastiche, fino alle linee KIDS e HAPPY pensate per i più piccoli. Concept innovativo e dotato di eccellente modularità è invece la linea BREAK, perfetta per arredare con stile e praticità eleganti sale colazioni o aree convegni.

Our range of self-service modules has been enriched with new lines and innovative solutions with proposals capable of satisfying the most varied aesthetic needs but above all capable of offering completely different uses, from the DROP-IN modules, designed to be able to adapt to any customized solution, to the OMNIA and ATHENA lines, perfect for furnishing self-service lines in company or school canteens, up to the KIDS and HAPPY lines designed for children. An innovative concept with excellent modularity is the BREAK line, perfect for furnishing elegant breakfast rooms or conference areas with style and practicality.



PROFESSIONAL FOODSERVICE SOLUTION

ROCAM

Smart breakfast



LOM
OLMO
ELM



RAL 7037
GRIGIO
GREY



NN
NICHEL NERO
BLACK NICKEL

Layout - Smart breakfast

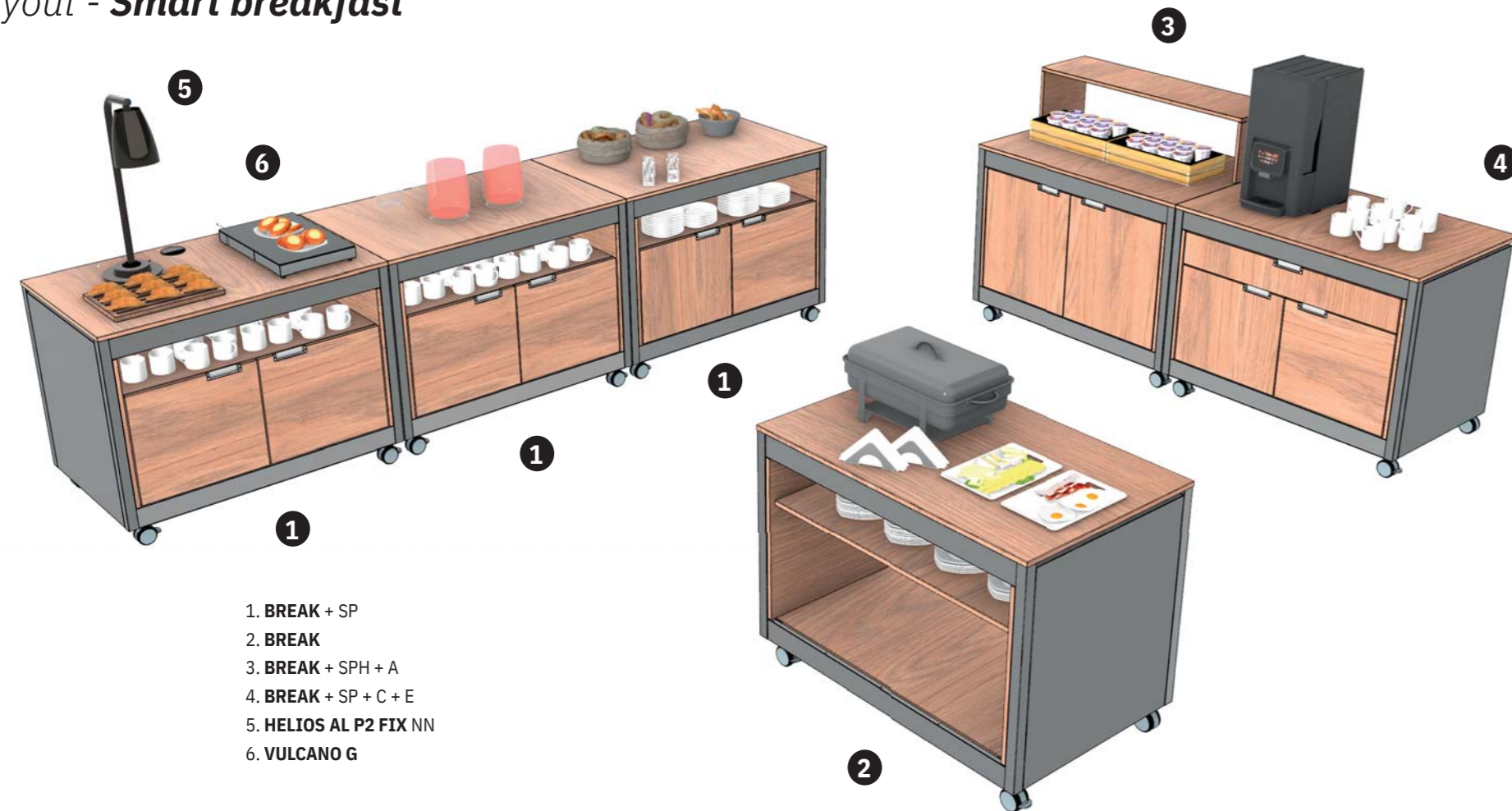

1. **BREAK + SP**
2. **BREAK**
3. **BREAK + SPH + A**
4. **BREAK + SP + C + E**
5. **HELIOS AL P2 FIX NN**
6. **VULCANO G**

IT I banchi neutri della linea BREAK permettono di configurare facilmente le piccole sale colazioni di hotel e B&B grazie all'alta personalizzazione garantita dai numerosi optional. Il design pulito si adatta ad una vasta gamma di ambienti e l'utilizzo da parte dei clienti è sempre agevole.

EN The neutral counters of the BREAK line make it easy to furnish small breakfast rooms in hotels and B&Bs, thanks to the high degree of customisation offered by the numerous options. The clean design adapts to a wide range of environments and is always easy for customers to use.

FR Les comptoirs neutres de la ligne BREAK permettent d'aménager facilement les petits espaces pour le petit-déjeuner dans les hôtels et les B&B, grâce au haut degré de personnalisation qu'offre les nombreuses options. Le design épuré s'adapte à une grande variété d'environnements et est toujours facile à utiliser pour les clients.

DE Die neutralen Module der BREAK-Linie erleichtern die Gestaltung kleiner Frühstücksräume in Hotels und B&Bs erheblich, da sie aufgrund ihrer zahlreichen Optionen äußerst individuell angepasst werden können. Das schlichte Design fügt sich nahtlos in verschiedene Umgebungen ein und bietet den Gästen stets eine benutzerfreundliche Bedienung.

ES Los mostradores neutros de la línea BREAK permiten configurar fácilmente las pequeñas salas de desayuno de hoteles y B&B gracias a la alta personalización garantizada por las numerosas opciones. El diseño limpio se adapta a una amplia gama de entornos y el uso por parte de los clientes siempre es cómodo.

Details



PANNELLATURA RESISTENTE IN NOBILITATO IDROFUGO
STURDY HYDROPHOBIC LAMINATED WOOD PANELING

RIPIANO REGOLABILE IN ALTEZZA
HEIGHT-ADJUSTABLE SHELF

2 RUOTE Ø 75 MM CON FRENO
2x Ø 75 MM POLYAMIDE WHEELS WITH BRAKE

STRUTTURA IN LAMIERA VERNICIATA AD ALTA RESISTENZA
POWDER COATED HIGH RESISTANCE STEEL STRUCTURE



ALZATE DISPONIBILI IN DIVERSI MODELLI POSIZIONABILI AL CENTRO (AC) O SUL RETRO DEL MODULO (A)
SHELF TO BE MOUNTED IN THE MIDDLE (AC) OR AT THE BACK (A) OF THE MODULE

ALLUNGO LATERALE
SIDE EXTENSION

PANNELLATURE PER LATO CLIENTE A CHIUSURA TOTALE (B) O PARZIALE (BB)
BACK FULL (B) OR PARTIAL (BB) PANELING

CASSETTONE (C) O CASSETTI DOPPI (C2)
SINGLE BIG DRAWER (C) OR DOUBLE DRAWERS (C2)



GESTIONE CAVI
CABLE MANAGEMENT



SISTEMA DI COMPOSIZIONE MODULARE CLICK CATCH®
CLICK CATCH® MODULAR CONNECTING SYSTEM



Conference bites



LOM
OLMO
ELM

RAL 9010
BIANCO PURO
PURE WHITE

LSV
SALVIA
SAGE



LTC
TERRACOTTA
CLAY

RAL 8017
CIOCCOLATO
CHOCOLATE



Layout - Conference bites

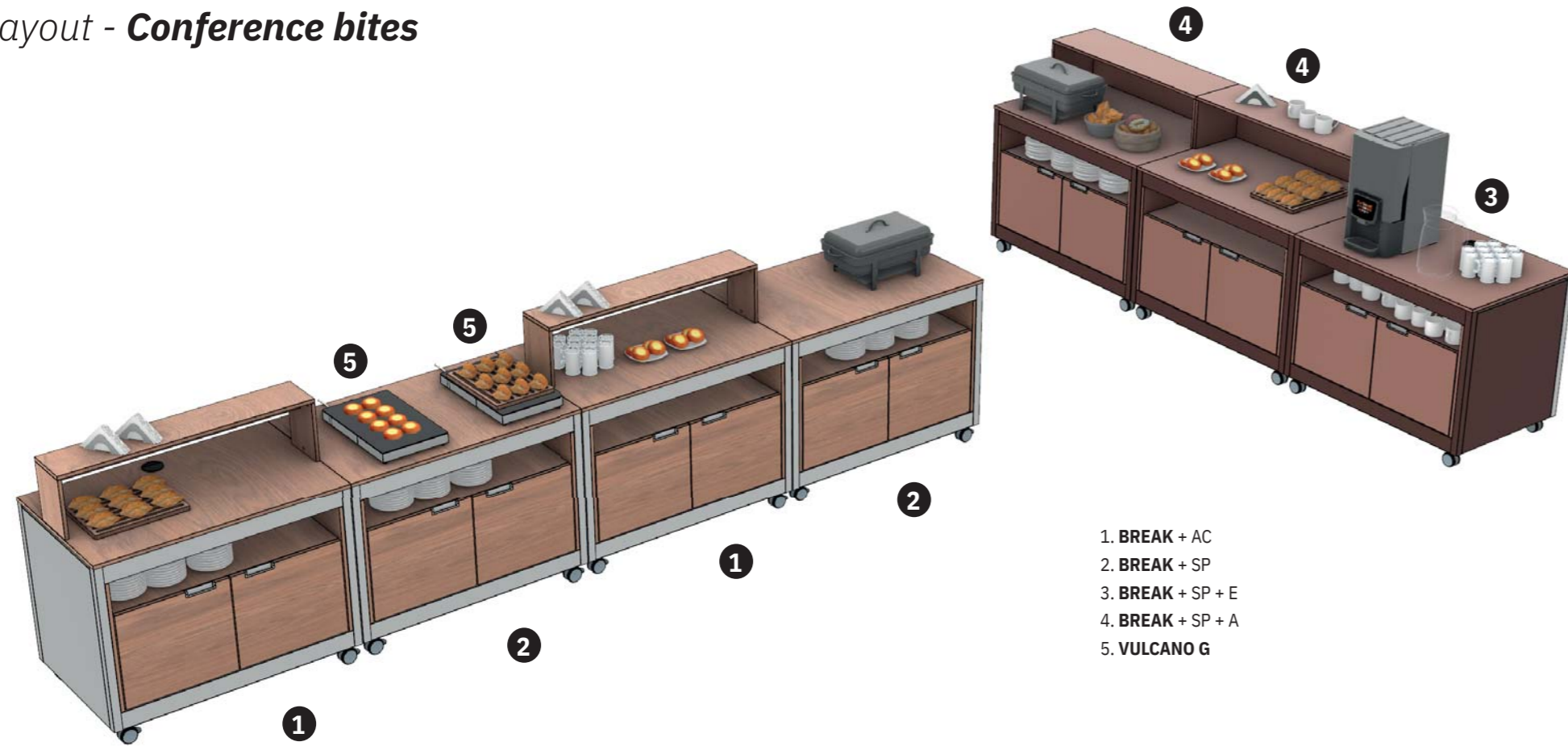

1. **BREAK + AC**
2. **BREAK + SP**
3. **BREAK + SP + E**
4. **BREAK + SP + A**
5. **VULCANO G**

IT Allestire catering e punti di ristoro all'interno di showroom e sale conferenze non è mai semplice per l'estrema variabilità di spazi e ambienti. Anche in questi casi BREAK, completato con i giusti optional, permette un'ottima adattabilità e con l'aggiunta degli eleganti piani caldi VULCANO G, rende lo spazio ancora più confortevole ed accogliente. La vasta gamma di finiture completa il prodotto per offrire una pausa di livello superiore.

EN Setting up catering and refreshment points in showrooms and conference rooms is never easy due to the extreme variability of spaces and environments. Also in these cases BREAK, completed with the right optionals, allows excellent adaptability and with the addition of the elegant VULCANO G hot surfaces, it makes the space even more comfortable and welcoming. The wide range of finishes completes the product to offer a superior level break.

FR Aménager des points de restauration et de rafraîchissement au sein de showrooms et de salles de conférence n'est jamais simple en raison des différents espaces et environnements. Dans ces cas également, BREAK, complété par les options appropriées, permet une excellente adaptabilité et, avec l'ajout des élégantes surfaces chauffantes VULCANO G, il rend l'espace encore plus confortable et accueillant. La large gamme de finitions complète le produit et offre un rendu de niveau supérieur.

DE Die Gestaltung von Catering- und Erfrischungsbereichen in Ausstellungs- und Konferenzräumen ist eine Herausforderung, da diese Räume äußerst vielfältig und wandelbar sind. Dennoch bietet BREAK, insbesondere in Kombination mit den passenden Optionen, eine bemerkenswerte Anpassungsfähigkeit. Durch die Integration eleganter VULCANO G-Wärmeplatten wird der Raum nicht nur komfortabler, sondern auch einladender. Die umfangreiche Auswahl an Oberflächen verleiht dem Produkt zudem eine erstklassige Note.

ES Instalar puntos de restauración y refrescos en showrooms y salas de conferencias nunca es fácil debido a la extrema variabilidad de los espacios y ambientes. También en estos casos BREAK, completado con los opcionales adecuados, permite una excelente adaptabilidad y, con la incorporación de las elegantes superficies calientes VULCANO G, hace que el espacio sea aún más confortable y acogedor. La amplia gama de acabados completa el producto para poder ofrecer un descanso de nivel superior.

Details

Colori struttura - Structure colours



RAL 9010 (+ LNO)
BIANCO PURO (+ LAMINATO NOCE)
PURE WHITE (+ LAMINATED WALNUT)



RAL 8017 (+ LWS)
CIOCCOLATO (+ LAMINATO SABBIA BIANCA)
CHOCOLATE (+ LAMINATED WHITE SAND)



RAL 7037 (+ LOM)
GRIGIO (+ LAMINATO OLMO)
GREY (+ LAMINATED ELM)

Optional principali - Main optionals



A
ALZATA DI SERVIZIO POSTERIORE
SPLASHBOARD ON THE BACKSIDE



AC
ALZATA DI SERVIZIO CENTRALE
CENTRAL UPPER SHELF



C
CASSETTONE SINGOLO
SINGLE BIG DRAWER



C2
COPPIA DI CASSETTI
DOUBLE DRAWERS



SP
COPPIA DI SPORTELLI
DOORS



TOP
RIVESTIMENTO IN INOX DEL PIANO
WORKTOP COATING IN STAINLESS STEEL



ANG
MODULO ANGOLARE 90° (SOLO PIANO)
90° ANGLE MODULE (SHELF ONLY)



E
PASSACAVI
DESK CABLE GLAND

Coffee corner



LWS
SABBIA BIANCA
WHITE SAND

Layout - Coffee corner



1

2

1. ALKOR 3B
2. ALKOR 2 AP



LOM
OLMO
ELM

- IT** Il design discreto ed elegante della linea ALKOR permette di ottenere corner per brevi pause all'interno degli uffici. Le linee essenziali e alcuni dettagli quali il piano regolabile in altezza per ALKOR AP e le ruote nascoste aiutano a mantenere gli ambienti in ordine.
- EN** The discreet and elegant design of the ALKOR line allows you to obtain corners for short breaks inside offices. The essential lines and some details such as the height-adjustable top for ALKOR AP and the hidden wheels help keep the rooms tidy.
- FR** Le design discret et élégant de la ligne ALKOR permet d'obtenir des espaces dédiés pour de courtes pauses au sein des bureaux. Les lignes essentielles et certains détails comme le plateau réglable en hauteur pour ALKOR AP et les roulettes cachées permettent de conserver les pièces élégamment rangées.
- DE** Das dezente und elegante Design der ALKOR-Linie ermöglicht es Ihnen, in Büros ruhige Ecken für kurze Pausen zu schaffen. Die klaren Linien und durchdachten Details, wie die höhenverstellbare Platte bei ALKOR AP und die verborgenen Rollen, sorgen für Ordnung in den Räumen.
- ES** El diseño discreto y elegante de la línea ALKOR permite obtener rincones para breves descansos en el interior de las oficinas. Las líneas esenciales y algunos detalles como el tablero regulable en altura para ALKOR AP y las ruedas ocultas, ayudan a mantener el orden en las habitaciones.



RIPIANO INTERMEDIO REGOLABILE
ADJUSTABLE MIDDLE SHELF



MOBILI SU RUOTE NASCOSTE
WAITER STATION ON HIDDEN CASTORS

Easy Buffet



LOM
OLMO
ELM



Layout - **Easy Buffet**



3

1. HEKO 6 MIX
2. HEKO SN
3. HEKO N



2

1

IT La forza della linea HEKO è la sua semplicità e funzionalità; con HEKO MIX ed HEKO SN, per esempio, bastano pochi elementi per arredare sale colazioni in modo completo e razionale, senza rinunciare ad un'estetica adatta agli ambienti più disparati.

EN The strength of the HEKO line is its simplicity and functionality; with HEKO MIX and HEKO SN, for example, a few elements are enough to furnish breakfast rooms in a complete and rational way, without renouncing an aesthetic suitable for the most diverse environments.

FR La force de la ligne HEKO réside dans sa simplicité et sa fonctionnalité. Avec HEKO MIX et HEKO SN, par exemple, quelques éléments suffisent pour aménager les salles de petit-déjeuner de manière complète et cohérente, tout en ne renonçant pas à l'esthétique adapté à chaque environnement.

DE Die HEKO-Linie glänzt durch ihre einfache und funktionale Gestaltung. Mit HEKO MIX und HEKO SN benötigen Sie nur wenige Teile, um Frühstücksräume praktisch und ästhetisch ansprechend einzurichten, die in verschiedenen Umgebungen gut zur Geltung kommen.

ES Los puntos fuertes de la línea HEKO son su sencillez y su funcionalidad; con HEKO MIX y HEKO SN, por ejemplo, unos pocos elementos son suficientes para amueblar los salones de desayuno de forma completa y racional, sin renunciar a una estética adecuada en los ambientes más diversos.



Premium buffet

LWS

SABBIA BIANCA
WHITE SAND

BL

NERO OPACO
MATTE BLACK

LOC

OCEANO
OCEAN

LSV

SALVIA
SAGE

LTC

TERRACOTTA
CLAY

- IT** Le linee architettoniche pulite ed allo stesso tempo raffinate di ATHENA permettono l'arredamento di sale ristorative di tutte le dimensioni. La cupola mobile realizzata in Plexiglass® per i moduli refrigerati permette un servizio efficiente con la massima igiene ed i piani caldi in vetro temperato assicurano sempre il mantenimento alla corretta temperatura dei piatti, offrendo esperienze di self service sempre uniche.
- EN** The clean and at the same time refined architectural lines of ATHENA allow the furnishing of dining rooms of all sizes. The mobile dome made of Plexiglass® for the refrigerated modules allows an efficient service with maximum hygiene and the hot plates in tempered glass always ensure that the dishes are kept at the correct temperature, offering always unique self-service experiences.
- FR** Les lignes architecturales à la fois épurées et raffinées d'ATHENA permettent l'aménagement de salles à manger de toutes tailles. Le dôme mobile en Plexiglass®, pour les modules réfrigérés, permet un service efficace avec une hygiène maximale. Les plaques chauffantes en verre trempé garantissent, elles, le maintien des plats à la bonne température. Ces équipements vous permettent d'offrir des expériences de libre-service uniques.

- DE** Die klaren und eleganten architektonischen Linien der ATHENA-Serie machen es einfach, Essbereiche jeder Größe einzurichten. Dank einer mobilen Plexiglas®-Abdeckung für die Kühlmodule wird ein effizienter und hygienischer Service ermöglicht. Die Kochplatten aus gehärtetem Glas sorgen dafür, dass die Speisen immer bei der richtigen Temperatur gehalten werden, und bieten so ein herausragendes Selbstbedienungserlebnis.
- ES** Las líneas arquitectónicas limpias y al mismo tiempo refinadas de ATHENA permiten amueblar comedores de todos los tamaños. La cúpula móvil en Plexiglass® para los módulos frigoríficos permite un servicio eficiente con la máxima higiene mientras que las placas calientes de vidrio templado garantizan que los platos se mantengan siempre a la temperatura correcta, ofreciendo experiencias de autoservicio siempre únicas.



Layout - Premium Buffet

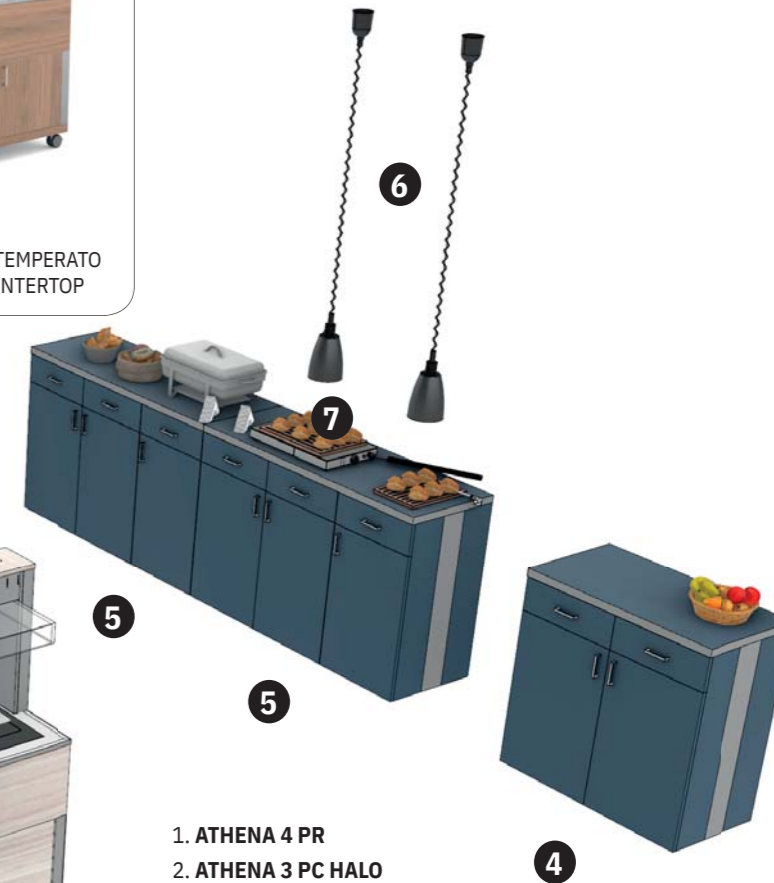
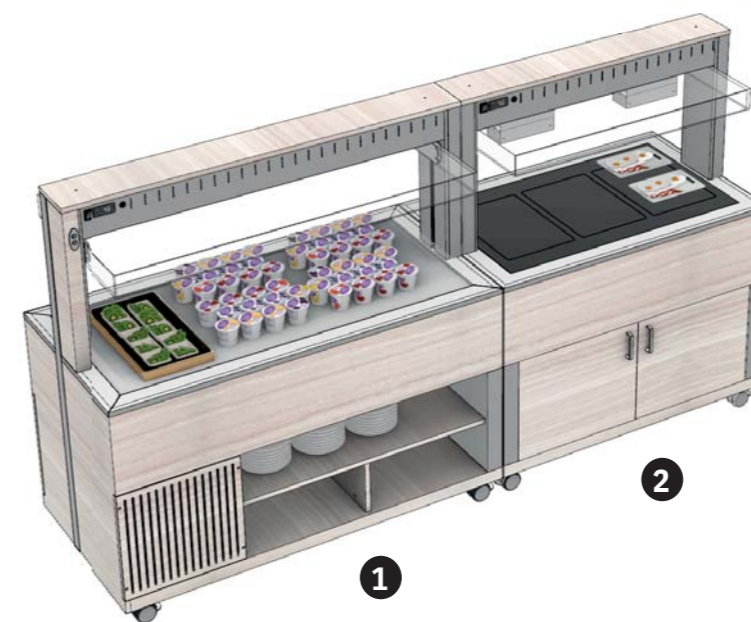

- 1. ATHENA 4 PR
- 2. ATHENA 3 PC HALO
- 3. ATHENA 4 BM
- 4. ALKOR 2B
- 5. ALKOR 3B
- 6. HELIOS AIR P2 BL
- 7. VULCANO G

Superior dining



NN
NICHEL NERO
BLACK NICKEL

LOM
OLMO
ELM

LGB
FORMICA® TOP
GRANITO BIANCO
WHITE GRANITE



BR
OTTONATO
BRASSED

LCP
CAPPUCCINO



NICCHIE PORTAPIATTI
CON ILLUMINAZIONE LED
NICHES FOR DISHES
WITH LED LIGHTING

LMR
MARMO GRIGIO
GREY MARBLE
Formica®



Layout - Superior dining

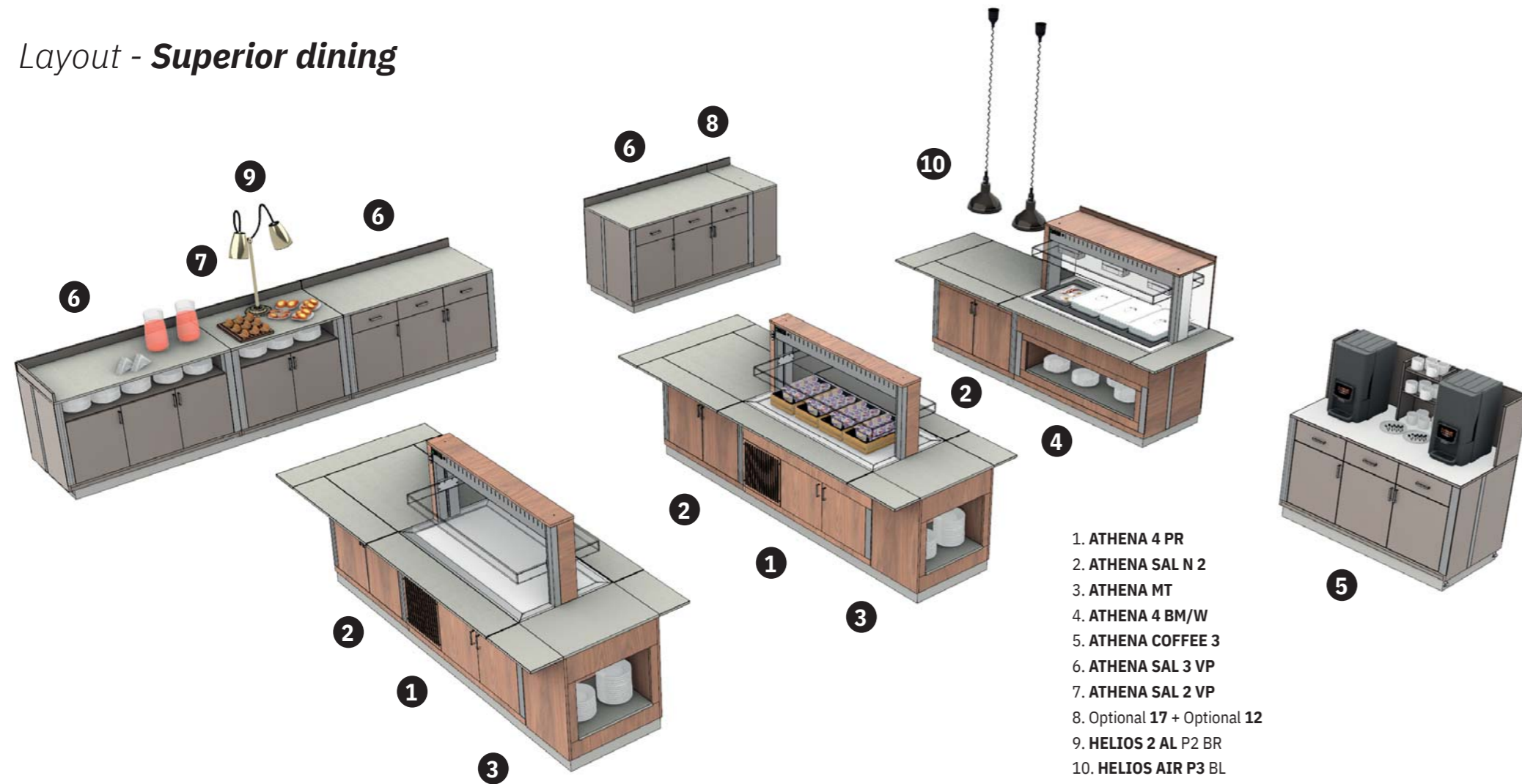

1. ATHENA 4 PR
2. ATHENA SAL N 2
3. ATHENA MT
4. ATHENA 4 BM/W
5. ATHENA COFFEE 3
6. ATHENA SAL 3 VP
7. ATHENA SAL 2 VP
8. Optional 17 + Optional 12
9. HELIOS 2 AL P2 BR
10. HELIOS AIR P3 BL

IT La vasta scelta di moduli e optional, disponibili per ATHENA, consentono l'allestimento anche per servizi self di grandi dimensioni. Dettagli come le nicchie porta piatti illuminate e la personalizzazione dei moduli neutri con top a contrasto, rappresentano solo alcuni degli elementi che caratterizzano il grande impatto visivo e funzionale della linea.

EN The vast choice of modules and option, available for ATHENA, also allow setting up for large self-services. Details such as the illuminated plate-holding niches and the customization of the neutral modules with contrasting tops represent just some of the elements that characterize the great visual and functional impact of the line.

FR Le vaste choix de modules et d'options, disponibles pour ATHENA, permet également de mettre en place de grandes structures libre-service. Des détails tels que les niches porte-assiettes éclairées et la personnalisation des modules neutres avec des plans contrastés, ne représentent que quelques-uns des éléments qui caractérisent l'élégance et la fonctionnalité de la ligne.

DE Die vielfältigen Module und Optionen von ATHENA erlauben es auch, großflächige Selbstbedienungsbereiche zu gestalten. Dazu gehören Details wie beleuchtete Ablageflächen für Teller und die Möglichkeit, die neutralen Module mit Kontrastplatten individuell anzupassen. Diese Merkmale verleihen der Produktlinie ein eindrucksvolles Erscheinungsbild und eine hohe Funktionalität.

ES La amplia variedad de módulos y opcionales disponibles para ATHENA también permite también la configuración de grandes autoservicios. Detalles como los nichos iluminados para los platos y la personalización de los módulos neutros con encimeras en contraste representan solo algunos de los elementos que caracterizan el gran impacto visual y funcional de la línea.



Finiture piano di lavoro - Worktop coatings



FORMICA® TOP LGN
GRANITO NERO - BLACK GRANITE



FORMICA® TOP LMR
MARMO GRIGIO - GREY MARBLE



FORMICA® TOP LGB
GRANITO BIANCO - WHITE GRANITE

Contemporary canteen



SST
ACCIAIO INOX
STAINLESS STEEL



CST
LAMIERA VERNICIATA
POWDER COATED STEEL
*COLORE SU RICHIESTA
RAL COLOR ON REQUEST



IT I moduli neutri, caldi e freddi della linea OMNIA permettono di configurare in modo efficiente mense che offrono ai clienti un servizio di tipo classico, permettendo al contempo di personalizzare l'estetica dei banchi e nobilitare i prodotti esposti. Carrelli mantenitori riscaldati a secco come THERMOVEGA completano l'allestimento.

EN The neutral, warm and cold modules of the OMNIA line allow you to efficiently configure canteens that offer customers a classic-type service, while allowing you to customize the aesthetics of the counters and ennoble the products on display. Dry heated holding trolleys such as THERMOVEGA complete the set-up.

FR Les modules neutres, chauds et froids de la gamme OMNIA permettent une configuration efficace des cantines, offrant aux clients un service de type classique, tout en ayant la possibilité de personnaliser l'esthétique des comptoirs et de sublimer les produits exposés. Des chariots de maintien de chaleur, chauffés à sec, tels que THERMOVEGA, complètent l'installation.

DE Die vielseitigen Module der OMNIA-Linie ermöglichen die einfache Gestaltung moderner Kantinen mit klassischem Service. Sie erlauben individuell anpassbare Theken und eine ansprechende Produktpräsentation. Zusätzlich runden beheizte Warmhaltungswagen wie der THERMOVEGA die Ausstattung ab.

ES Los módulos neutros, cálidos y fríos de la línea OMNIA permiten configurar eficientemente comedores que ofrecen a los clientes un servicio de tipo clásico y al mismo tiempo permiten personalizar la estética de los mostradores y ennoblecer los productos expuestos. Los Carros de mantenimiento en seco calentados como el THERMOVEGA completan el equipamiento.

Layout - Contemporary canteen

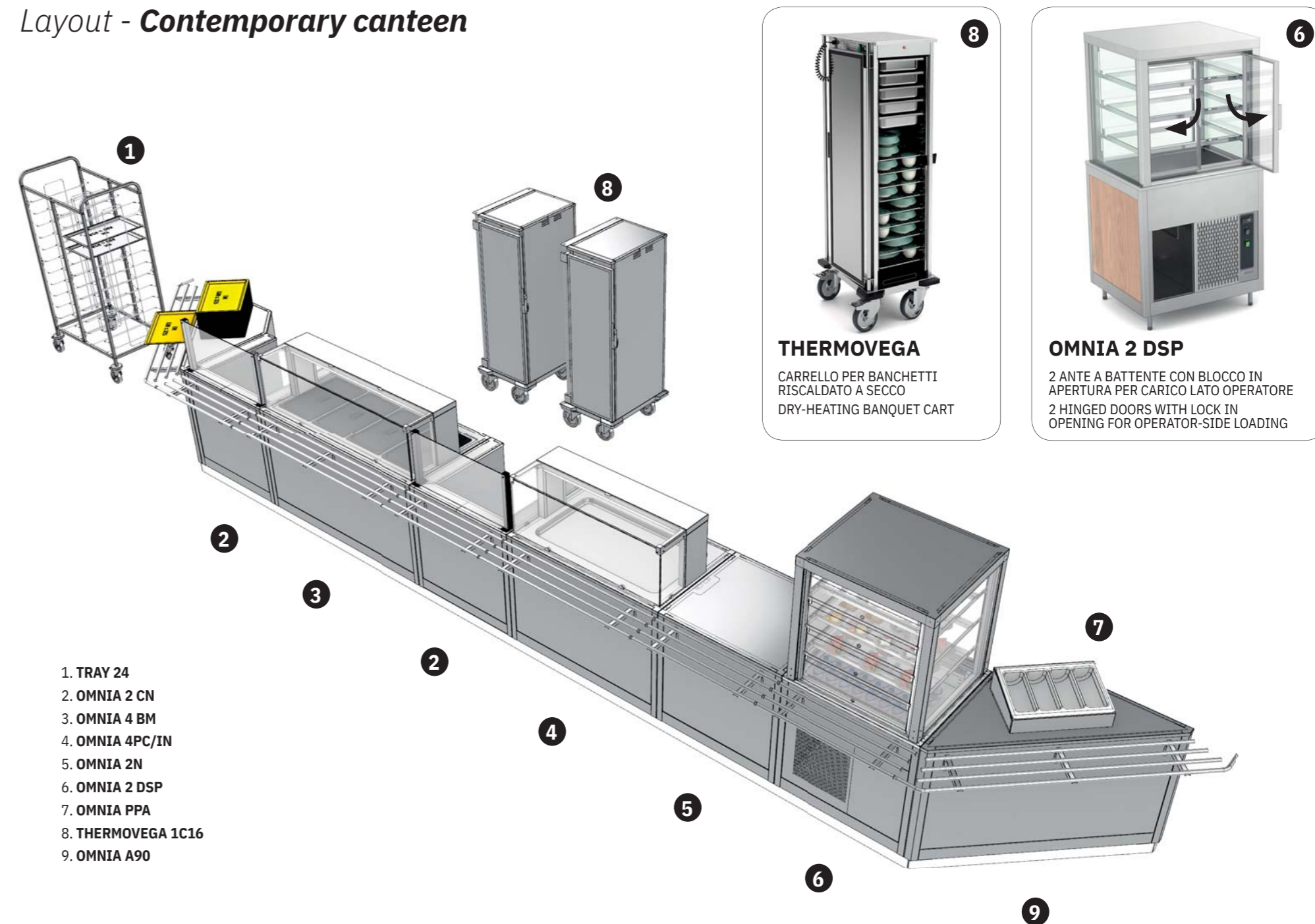

- 1. TRAY 24
- 2. OMNIA 2 CN
- 3. OMNIA 4 BM
- 4. OMNIA 4PC/IN
- 5. OMNIA 2N
- 6. OMNIA 2 DSP
- 7. OMNIA PPA
- 8. THERMOVEGA 1C16
- 9. OMNIA A90

Elegant canteen

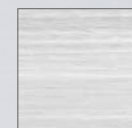

LWS

SABBIA BIANCA
WHITE SAND



IT La grande gamma di finiture disponibili per le pannellature di OMNIA permette un'alta adattabilità ai più disparati ambienti rendendo il servizio un'esperienza sempre piacevole per clienti e operatori. La pausa pranzo non è mai stata così bella.

EN The large range of finishes available for the OMNIA paneling allows for high adaptability to the most diverse environments, making the service an always pleasant experience for customers and operators. The lunch break has never been so beautiful.

FR La large gamme de finitions disponibles pour les panneaux OMNIA permet une grande adaptabilité aux environnements les plus divers, faisant du service une expérience toujours agréable pour les clients et les opérateurs. La pause déjeuner n'a jamais été aussi belle.

DE Die vielfältigen Verkleidungsmöglichkeiten der OMNIA-Linie passen sich ausgezeichnet an unterschiedliche Umgebungen an und schaffen somit ein angenehmes Erlebnis für Kunden und Betreiber gleichermaßen. Die Mittagspause war selten so genussvoll.

ES La amplia gama de acabados disponibles para los paneles OMNIA permite una alta adaptabilidad a los más diversos entornos, haciendo del servicio una experiencia siempre agradable para clientes y operadores. La pausa para el almuerzo nunca ha sido tan bonita.



CO
 VANO INFERIORE CON CASSETTIERE
 LOWER COMPARTMENT WITH DRAWERS

PHOT
 PIANO INOX INTERMEDIO PER VANO INFERIORE
 RISCALDATO (PER MODELLI OMNIA /SC)
 STAINLESS STEEL MIDDLE SHELF FOR LOWER
 HEATED COMPARTMENT (FOR OMNIA /SC
 MODELS)

Layout - *Elegant canteen*

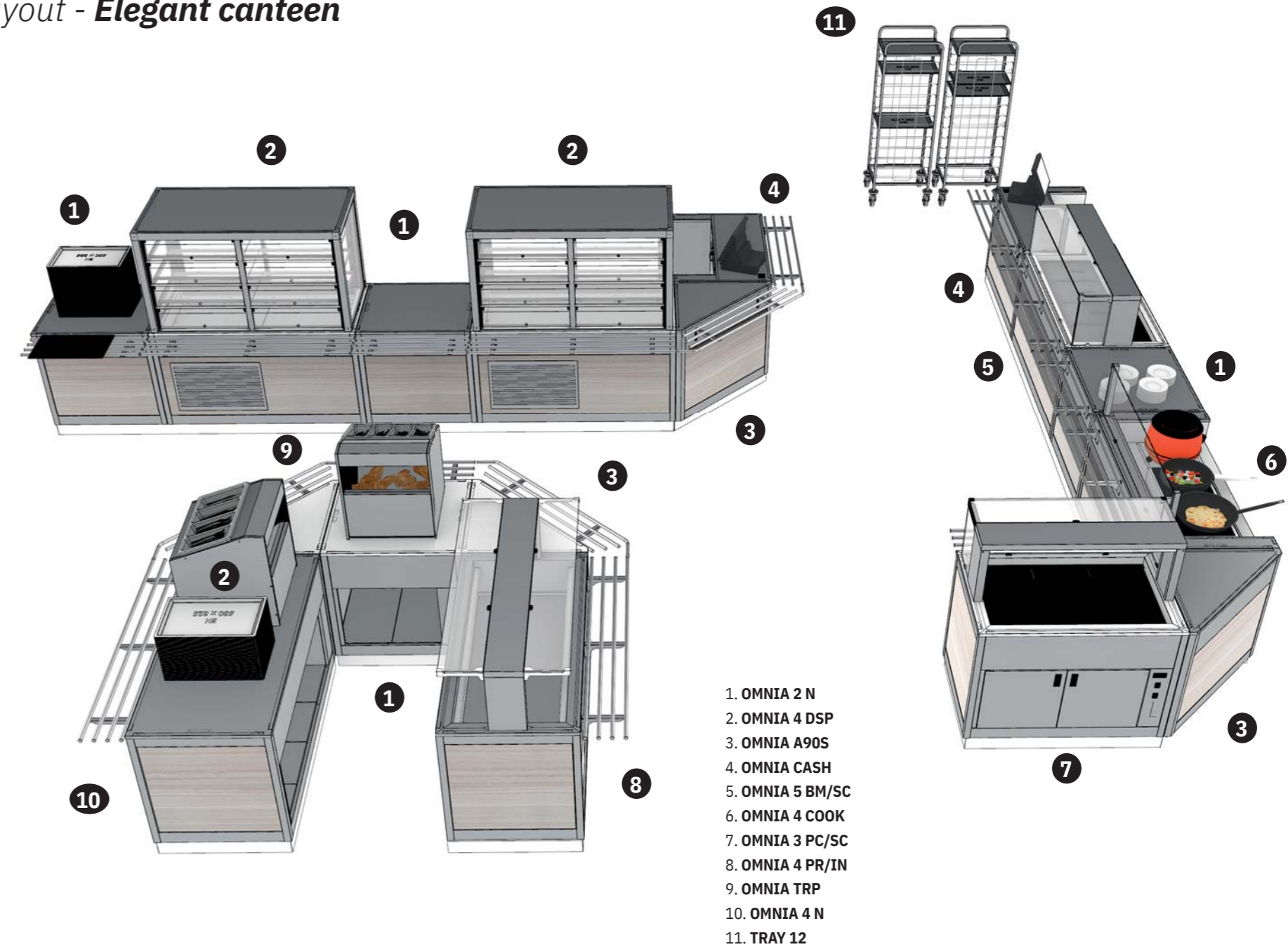

Company cafeteria



LOM
OLMO
ELM

- IT** La versatilità e la pulizia nel design della linea OMNIA permettono di creare funzionali ma al tempo stesso eleganti ambienti conviviali all'interno delle aziende, dove i dipendenti possono passare piacevoli momenti all'insegna del relax. La funzionalità è garantita da moduli per la raccolta differenziata come OMNIA BIN e dai carrelli TRAY per la raccolta dei vassoi.
- EN** The versatility and clean design of the OMNIA line make it possible to create functional but at the same time elegant convivial environments within companies, where employees can spend pleasant moments of relaxation. Functionality is guaranteed by modules for differentiated collection such as OMNIA BIN and by TRAY trolleys for collecting trays.
- FR** La polyvalence et le design épuré de la ligne OMNIA permettent de créer des environnements conviviaux à la fois fonctionnels et élégants au sein des entreprises, où les employés peuvent passer d'agréables moments de détente. La fonctionnalité est garantie par des modules de collectes différenciés tels que OMNIA BIN et par des chariots TRAY pour les bacs de collecte.

- DE** Die OMNIA-Linie besticht durch Vielseitigkeit und ein schlichtes Design. Damit schafft sie in Unternehmen funktionale und dennoch elegante und einladende Räume. Um die Funktionalität sicherzustellen, können spezielle Module wie OMNIA BIN und TRAY-Wagen für Auffangwannen verwendet werden.
- ES** La versatilidad y el diseño limpio de la línea OMNIA permiten crear ambientes funcionales, pero al mismo tiempo elegantes y apacibles dentro de las empresas, donde los empleados pueden pasar agradables momentos de relajación. La funcionalidad está garantizada por módulos de recogida diferenciada como OMNIA BIN y por carros TRAY para bandejas recogedoras.





Layout - **Company cafeteria**

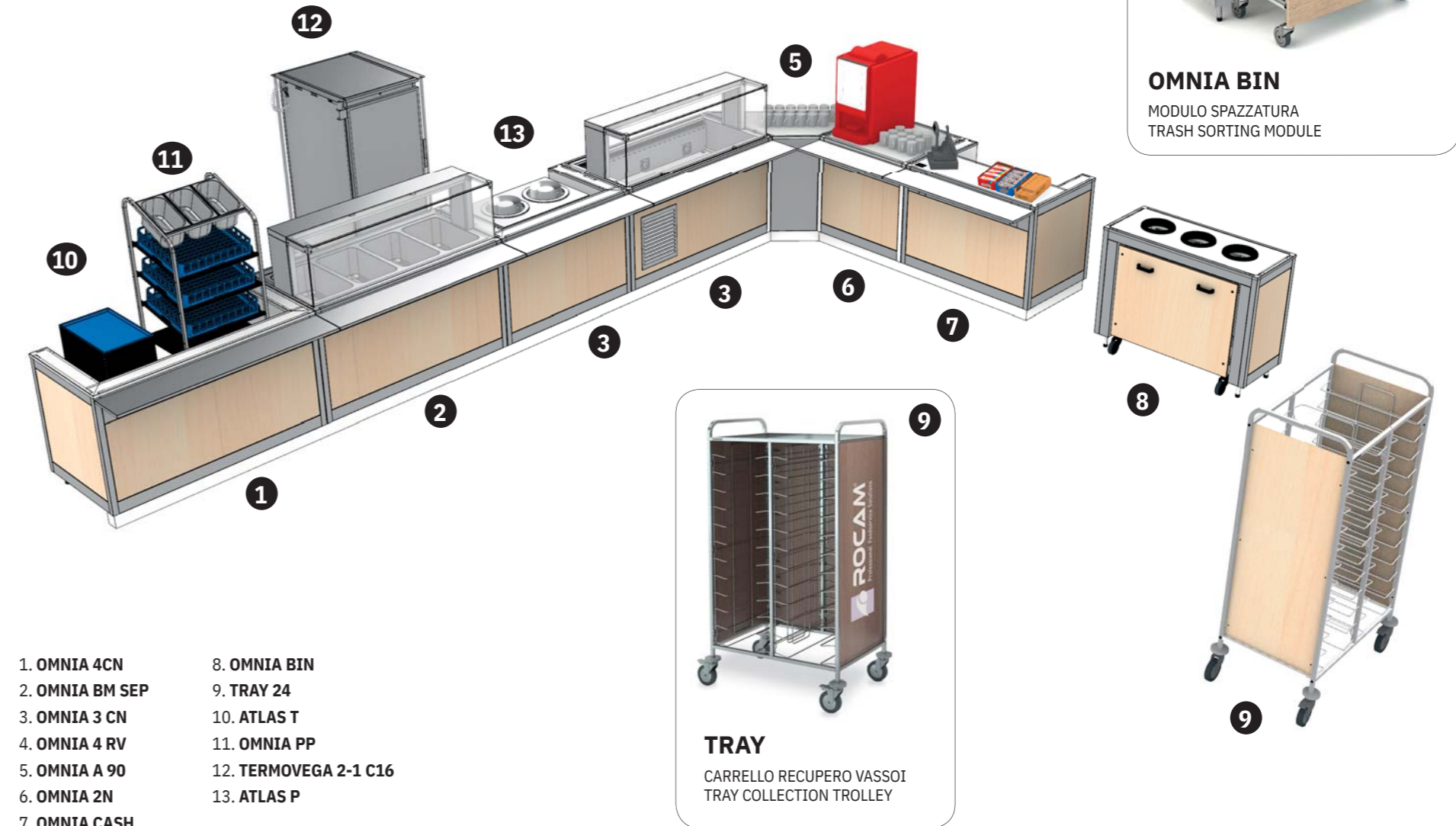

Food retail solutions



LNO
NOCE
WALNUT

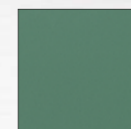

LER
EDERA
IVY

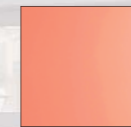

CO
RAMATO
COPPER



LTC
TERRACOTTA
CLAY



LBE
BETULLA
BIRCH

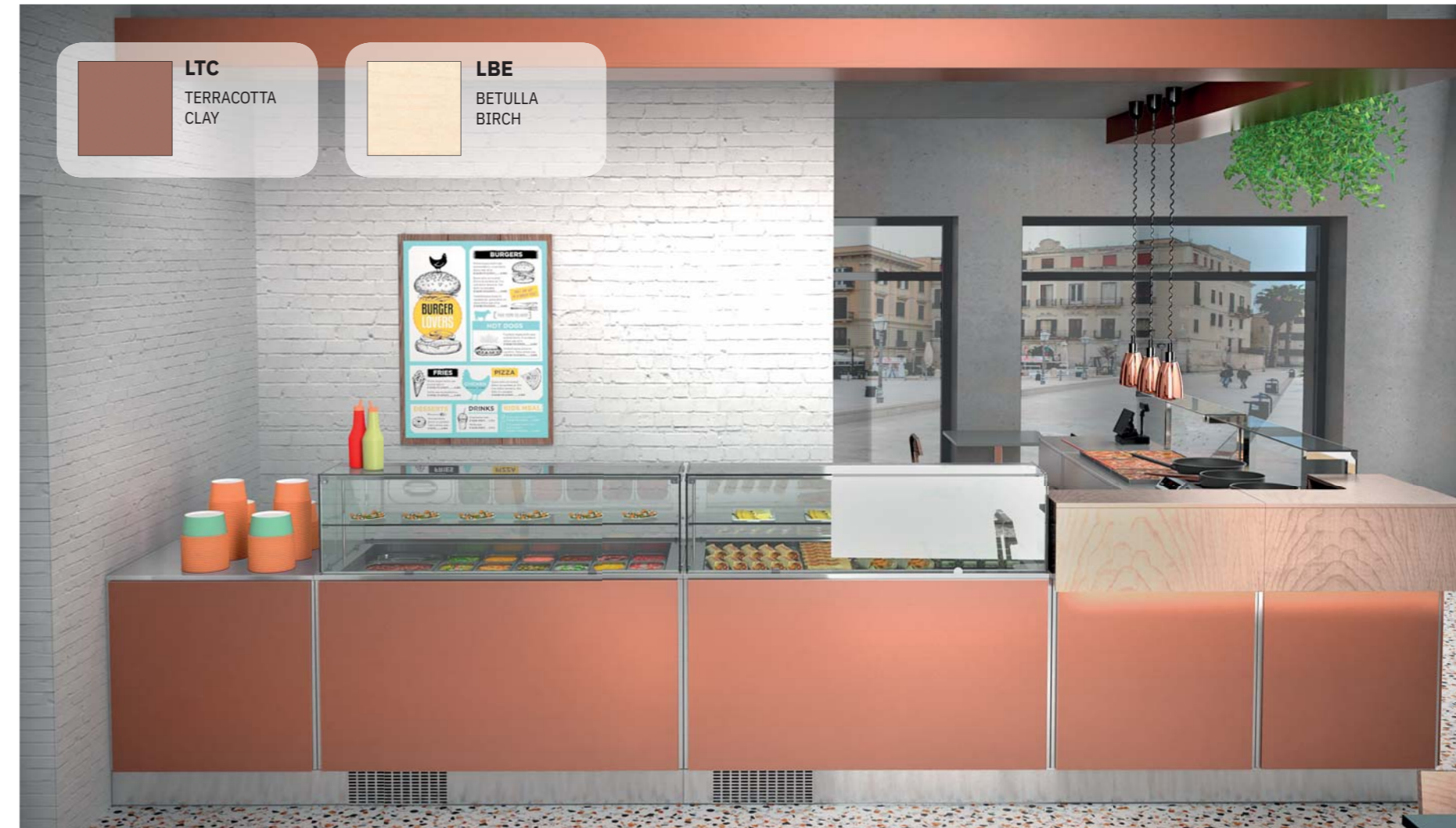

- IT** Uno degli aspetti più importanti nell'ambito food retail è riuscire ad offrire ogni volta una presentazione che esalti i cibi e grazie ad OMNIA configurato con vetrina G6 questo obiettivo è sempre raggiunto. Pannellature complete nella parte frontale della linea e alti zoccolini in acciaio contribuiscono a creare ambienti accoglienti e dall'alto valore estetico.
- EN** One of the most important aspects in the food retail sector is being able to offer a presentation that enhances the food every time and thanks to OMNIA configured with a G6 showcase this goal is always achieved. Complete paneling in the front part of the line and high steel plinths help to create welcoming environments with a high aesthetic value.
- FR** L'un des aspects les plus importants dans le secteur de la vente au détail des produits alimentaires est de pouvoir offrir une présentation mettant toujours en valeur les aliments. Grâce à OMNIA, configuré avec une vitrine G6, cet objectif est atteint en permanence. Des panneaux complets dans la partie avant de la ligne et de hauts socles en acier contribuent à créer des environnements accueillants tout en conservant une grande esthétique.

- DE** Im Lebensmitteleinzelhandel ist es wichtig, die Produkte ansprechend zu präsentieren. Mit OMNIA und der G6-Vitrine ist das möglich. Die durchgehende Verkleidung im vorderen Teil der Linie sowie hohe Stahlsockel tragen dazu bei, einladende und attraktive Umgebungen zu schaffen.
- ES** Uno de los aspectos más importantes en el sector del retail de alimentación es poder ofrecer una presentación que realce cada vez la comida, y gracias a OMNIA configurado con un escaparate G6 este objetivo siempre se consigue. Paneles completos en la parte frontal de la línea y zócalos altos de acero ayudan a crear ambientes acogedores y de alto valor estético.



Layout - Food retail solutions

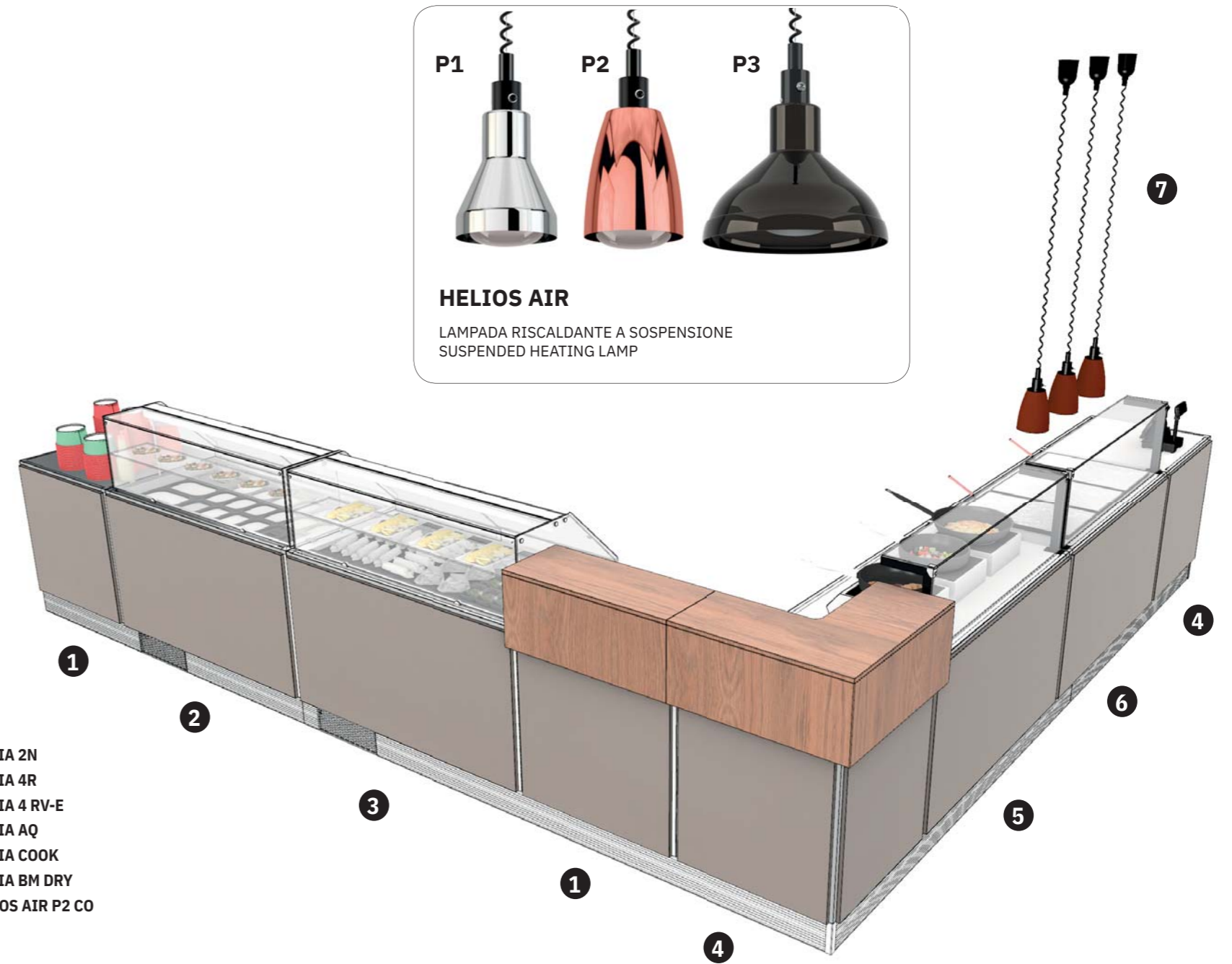

Food retail solutions



LOC
OCEANO
OCEAN

LOM
OLMO
ELM



IT I banchi neutri di OMNIA, configurati con piani caldi e paratia G5, permettono di configurare anche piccoli negozi, rosticcerie e tutte quelle attività che richiedono servizi veloci ed efficienti. La riserva calda e ventilata dei moduli SC contribuisce ad aumentare l'efficienza del servizio.

EN OMNIA's neutral counters, configured with hot plates and G5 bulkhead, allow you to configure even small shops, takeaways and all those activities that require fast and efficient services. The hot and ventilated reserve of the SC modules helps to increase the efficiency of the service.

FR Les comptoirs neutres d'OMNIA, configurés avec plaques chauffantes et cloison G5, vous permettent de configurer même les plus petits magasins, les plats à emporter et toutes ces activités qui nécessitent des services rapides et efficaces. La réserve chaude et ventilée des modules SC vous aide à augmenter l'efficacité du service.

DE Die neutralen OMNIA-Theken mit Kochplatten und G5-Schott ermöglichen die effiziente Gestaltung von kleinen Geschäften, Imbissbuden und anderen Betrieben, die schnelle und effiziente Serviceleistungen erfordern. Die beheizten und belüfteten Reservebereiche der SC-Module tragen zur Steigerung der Serviceeffizienz bei.

ES Los mostradores neutros de OMNIA, configurados con placas eléctricas y mampara G5, permiten configurar incluso pequeños comercios, comida para llevar y todas aquellas actividades que requieran servicios rápidos y eficientes. La reserva caliente y ventilada de los módulos SC ayuda a incrementar la eficiencia del servicio.



CO

VANO INFERIORE CON CASSETTIERE
LOWER COMPARTMENT WITH DRAWERS



/SC

VANO INFERIORE RISCALDATO
HEATED LOWER COMPARTMENT



PR2

PRESA A INCASSO SCHUKO
CON SPORTELLINO
SCHUKO PLUG WITH LID



Layout - Food retail solutions

1. **OMNIA 4 N + G5**
2. **OMNIA 4 N + CO2 + ADS + AL/CO**
3. **VULCANO 4/1**



1



VULCANO

PIANO CALDO
FOOD WARMERS

2

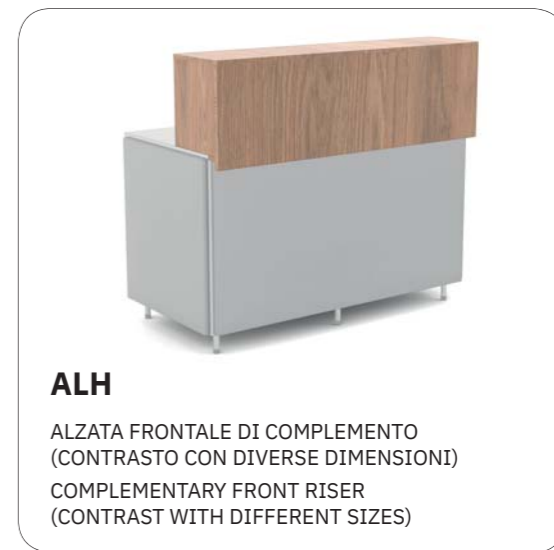

ALH

ALZATA FRONTALE DI COMPLEMENTO
(CONTRASTO CON DIVERSE DIMENSIONI)
COMPLEMENTARY FRONT RISER
(CONTRAST WITH DIFFERENT SIZES)

Your design, our technology

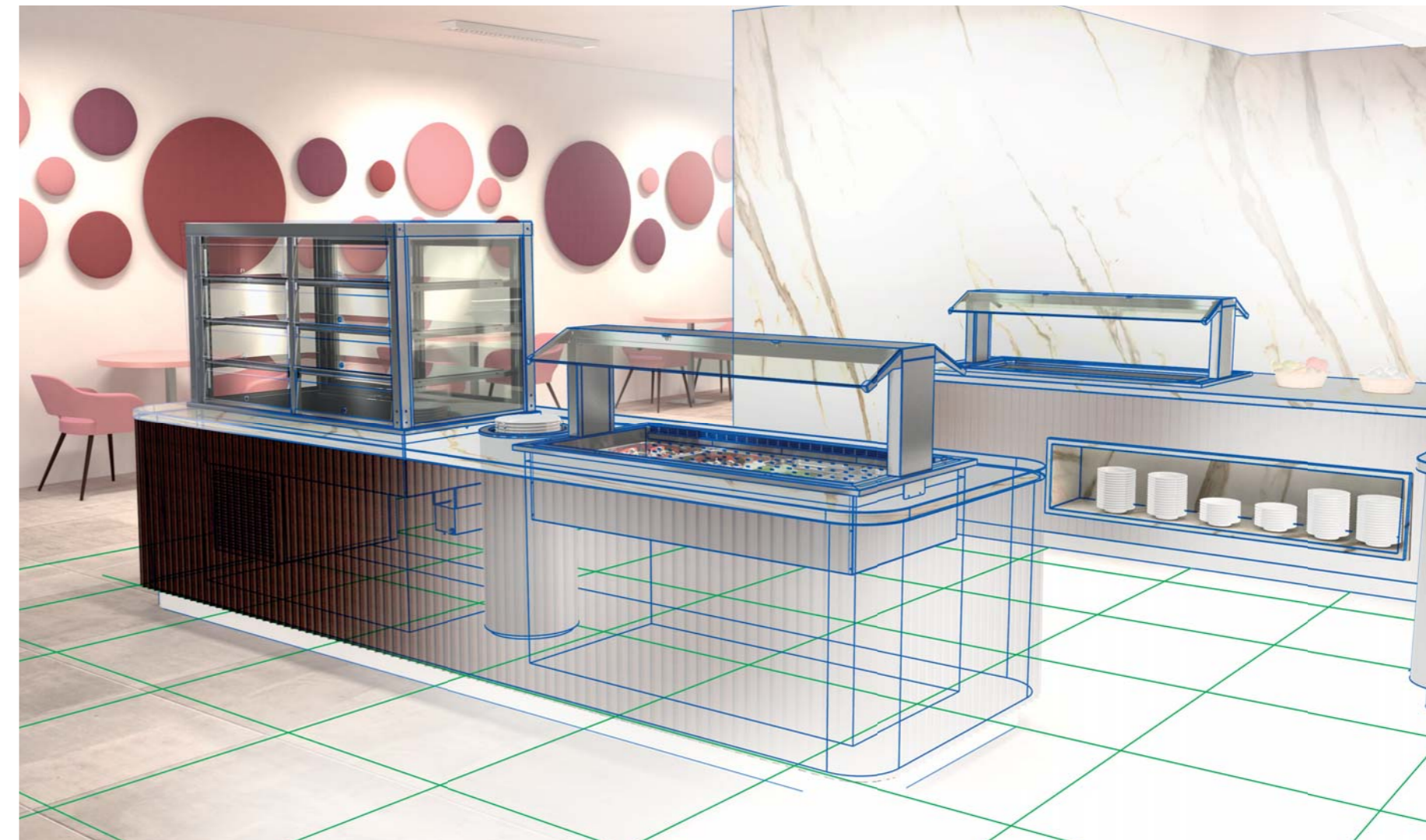

IT La tecnologia ROCAM dei moduli della linea DROP-IN permette configurazioni uniche, in grado di rispondere alle richieste degli architetti e designer più esigenti. L'alta configurabilità che distingue tutta la linea dei prodotti ROCAM, permette l'inserimento di questi moduli in banchi unici e realizzati su misura.

EN The ROCAM technology of the modules of the DROP-IN line allows unique configurations, capable of responding to the requests of the most demanding architects and designers. The high configurability that distinguishes the entire ROCAM product line allows the insertion of these modules in unique and custom-made benches.

FR La technologie ROCAM des modules de la ligne DROP-IN permet des configurations uniques, capables de répondre aux demandes des architectes et designers les plus exigeants. La facilité de configuration qui distingue toute la gamme de produits ROCAM permet l'insertion de ces modules dans des bancs uniques et personnalisés.

DE Die ROCAM-Technik in den Modulen der DROP-IN-Linie eröffnet zahlreiche Konfigurationsmöglichkeiten. Dank der hohen Anpassungsfähigkeit, die die gesamte ROCAM-Produktlinie bietet, können diese Module problemlos in maßgeschneiderte Buffets integriert werden.

ES La tecnología ROCAM de los módulos de la línea DROP-IN permite configuraciones únicas, capaces de responder a las solicitudes de los arquitectos y diseñadores más exigentes. La alta configurabilidad que distingue toda la línea de productos ROCAM permite la inserción de estos módulos en bancos únicos y personalizados.



4

DROD-IN PR-IN
PIANO REFRIGERATO INOX
STAINLESS STEEL REFRIGERATED COUNTERTOP



3

DROD-IN PC
PIANO RISCALDATO IN VETRO TEMPERATO
TEMPERED GLASS HEATED COUNTERTOP

Layout - Your design, our technology

- 1. DROD-IN DSP
- 2. DROD-IN R
- 3. DROD-IN PC
- 4. DROD-IN PR/IN
- 5. HELIOS AIR
- 6. DROD-IN PLC



1

DROD-IN DSP
VETRINA REFRIGERATA VENTILATA
FAN-ASSISTED REFRIGERATED DISPLAY CASE

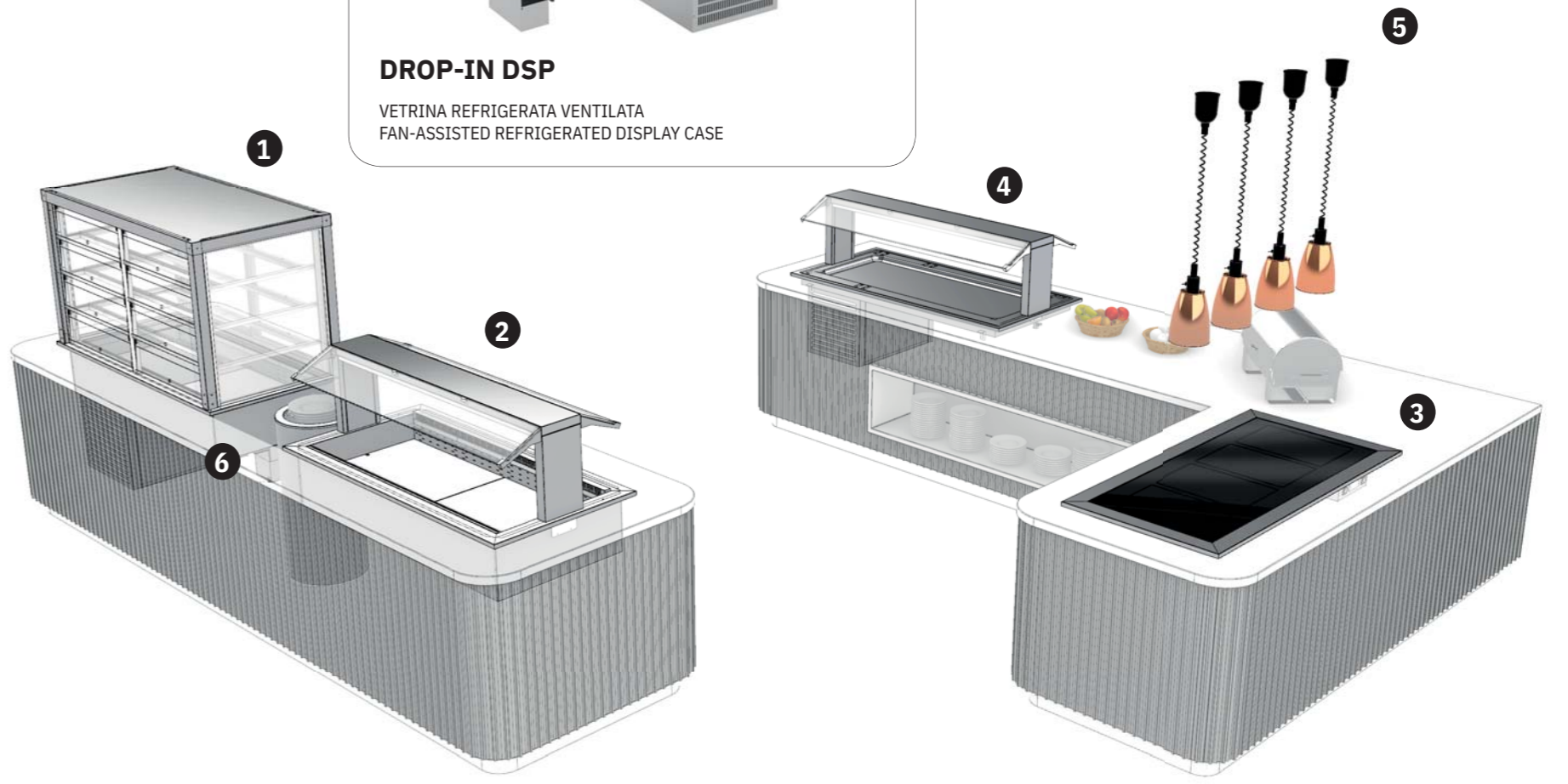

Food for new generations



LSK
CIELO
SKY

LRS
ROSE
ROSE



LIM
LIME

LSK
CIELO
SKY

ADS
ADESIVO PER PERSONALIZZAZIONE
STICKERS WITH BESPOKE GRAPHICS

- IT** La linea HAPPY, adatta ad allestire la distribuzione pasti nelle scuole elementari e all'interno dei corner bambini dei family hotel, permette un servizio sempre agevole ed efficiente. Le ribalte di serie con bordi stondati, la protezione per il pannello comandi dei moduli caldi, la gamma decori con colori accesi e la possibilità di personalizzare i banchi con adesivi (opt. ADS) rendono il servizio sicuro e divertente.
- EN** The HAPPY line, suitable for setting up the distribution of meals in elementary schools and in the children's corners of family hotels, allows for an always easy and efficient service. The standard flap doors with rounded edges, the protection for the control panel of the hot modules, the range of decorations with bright colors and the possibility of personalizing the counters with stickers (opt. ADS) make the service safe and enjoyable.
- FR** La ligne HAPPY, adaptée à la mise en place de la distribution de repas dans les écoles primaires et dans les coins enfants des hôtels familiaux, permet un service facile et efficace. Les portes battantes standards aux bords arrondis, la protection du panneau de commande des modules chauds, la gamme de décorations aux couleurs vives et la possibilité de personnaliser les comptoirs avec des autocollants (opt. ADS) rendent le service sûr et agréable.

- DE** Die HAPPY-Linie ist ideal für Essensausgaben in Grundschulen und in Kinderbereichen von Familienhotels geeignet. Sie ermöglicht einen einfachen und effizienten Service. Standardmäßige Tellerablagen mit abgerundeten Kanten, ein Schutz für das Bedienfeld der heißen Module, lebendige Farbdekorationen und die Möglichkeit zur Personalisierung der Theken mit Aufklebern (optional ADS) runden das Angebot ab.
- ES** La línea HAPPY, adecuada para la distribución de comidas en las escuelas primarias y en los rincones infantiles de los hoteles familiares, permite un servicio siempre sencillo y eficaz. Las puertas abatibles de serie con bordes redondeados, la protección del panel de control de los módulos calientes, la gama de decoraciones con colores vivos y la posibilidad de personalizar los mostradores con adhesivos (opc. ADS) hacen que el servicio sea seguro y agradable.

Layout - **Food for new generations**



ALTEZZA DEI BUFFET DA 50* A 70 CM CON 2 RIBALTE DI SERIE, PROGETTATO SU MISURA PER BAMBINI

HEIGHT OF THE BUFFETS FROM 50* TO 70 CM, TWO FOLDABLE DISH HOLDER ALWAYS INCLUDED, SPECIFIC FOR KIDS

*Disponibile solo per Happy BM - Only available for Happy BM



PANNELLO COMANDI BM CON PROTEZIONE
PROTECTED CONTROL PANEL



RIBALTE STONDATE DI SICUREZZA
DISH-HOLDER WITH ROUNDED EDGES

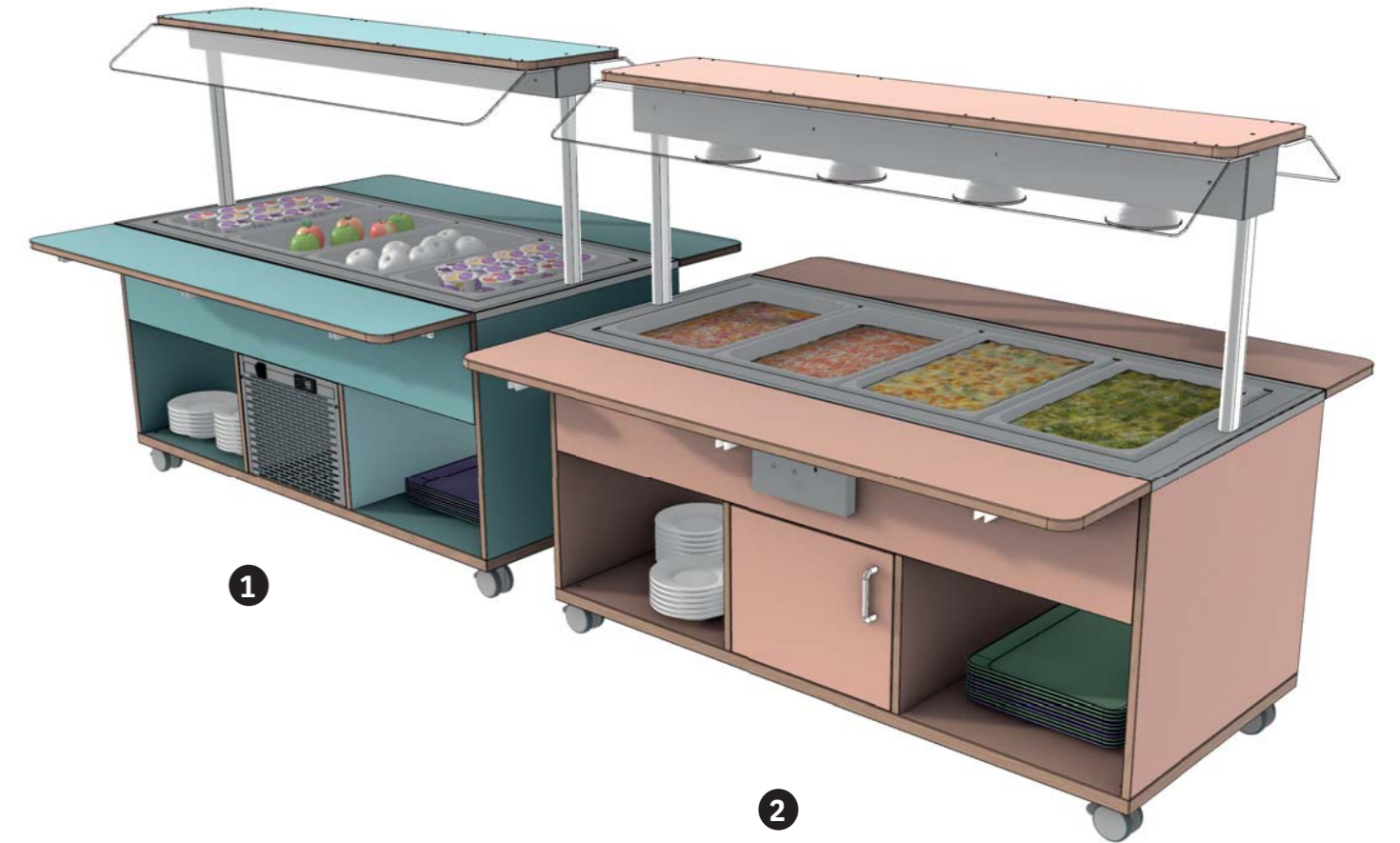

1- **HAPPY 4 R**
2- **HAPPY 4 BM-HALO**

Primary school cafeteria

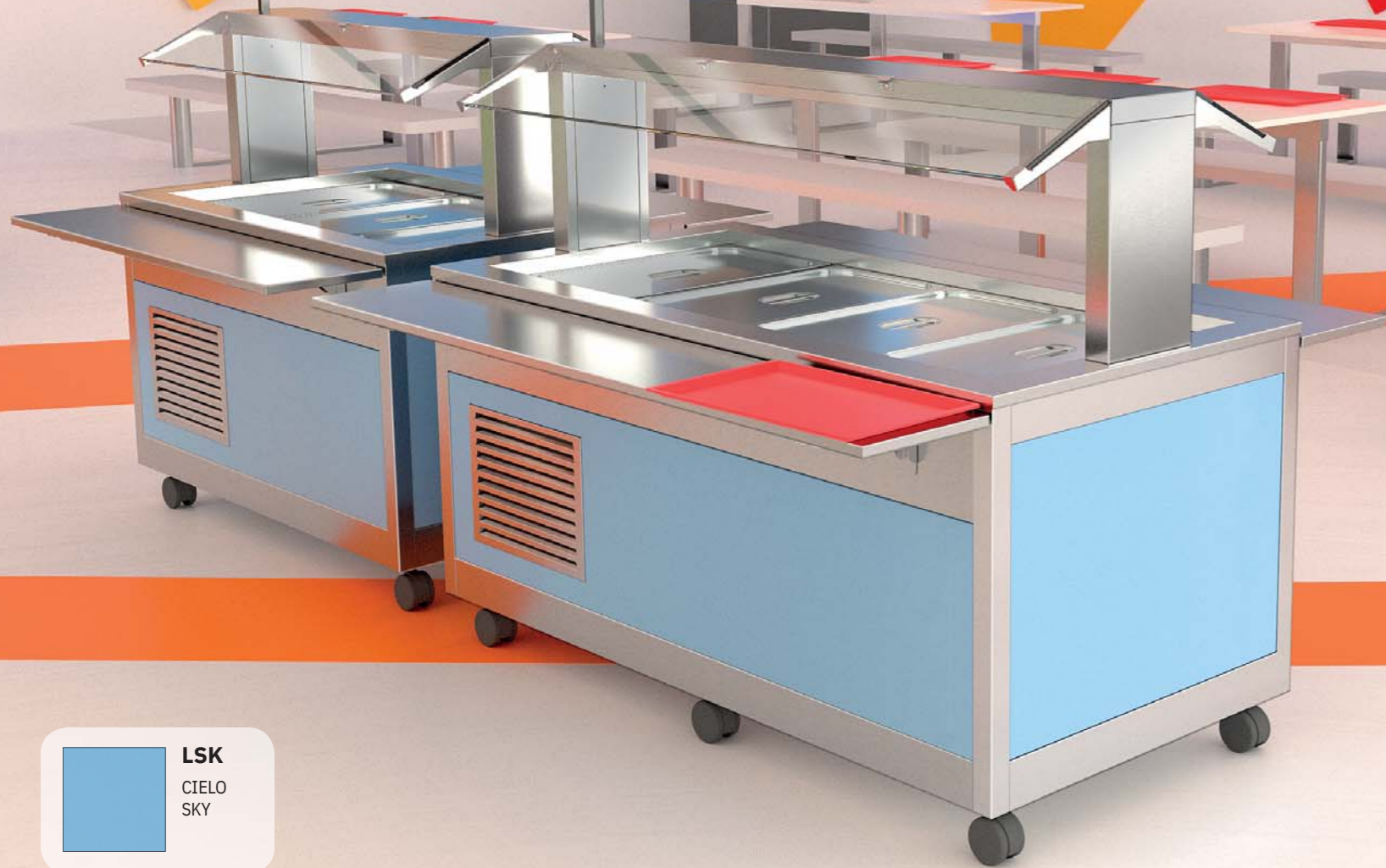

LSK
CIELO
SKY

75 cm



LIM
LIME

IT La linea KIDS, realizzata in acciaio e configurabile con pannelli in legno o metallo, offre un'altezza ribassata (75cm) rispetto ai classici moduli self service. L'optional TUBE consente di tener lontano i bambini dalle parti elettriche, offrendo un servizio mensa affidabile e funzionale per tutti, bambini e operatori su tutti.

EN The KIDS line, made of steel and configurable with wooden or metal panels, offers a lowered height (75cm) compared to the classic self-service modules. The TUBE optional allows children to be kept away from electrical parts, offering a reliable and functional canteen service for everyone, children and operators above all.

FR La ligne KIDS, réalisée en acier et configurable avec des panneaux en bois ou en métal, offre une hauteur abaissée (75 cm) par rapport aux modules libre-service classiques. L'option TUBE permet d'éloigner les enfants des parties électriques, offrant ainsi un service de cantine sécurisé et fonctionnel pour les enfants.

DE Die KIDS-Linie besteht aus einem Edelstahl-Korpus und lässt sich mit Holz- oder Metallpaneelen kombinieren. Sie ist mit 75 cm niedriger als herkömmliche Selbstbedienungsmodule. Die optionale TUBE-Funktion sorgt dafür, die Stromversorgung auch von der Decke zu ermöglichen. Dadurch sind elektrische Anschlüsse für Kinder unzugänglich.

ES La línea KIDS, realizada en acero y configurable con paneles de madera o metal, ofrece una altura rebajada (75 cm) respecto a los clásicos módulos de autoservicio. El TUBE opcional permite mantener a los niños alejados de los componentes eléctricos, ofreciendo un servicio de comedor fiable y funcional para todos, sobre todo niños y operadores.

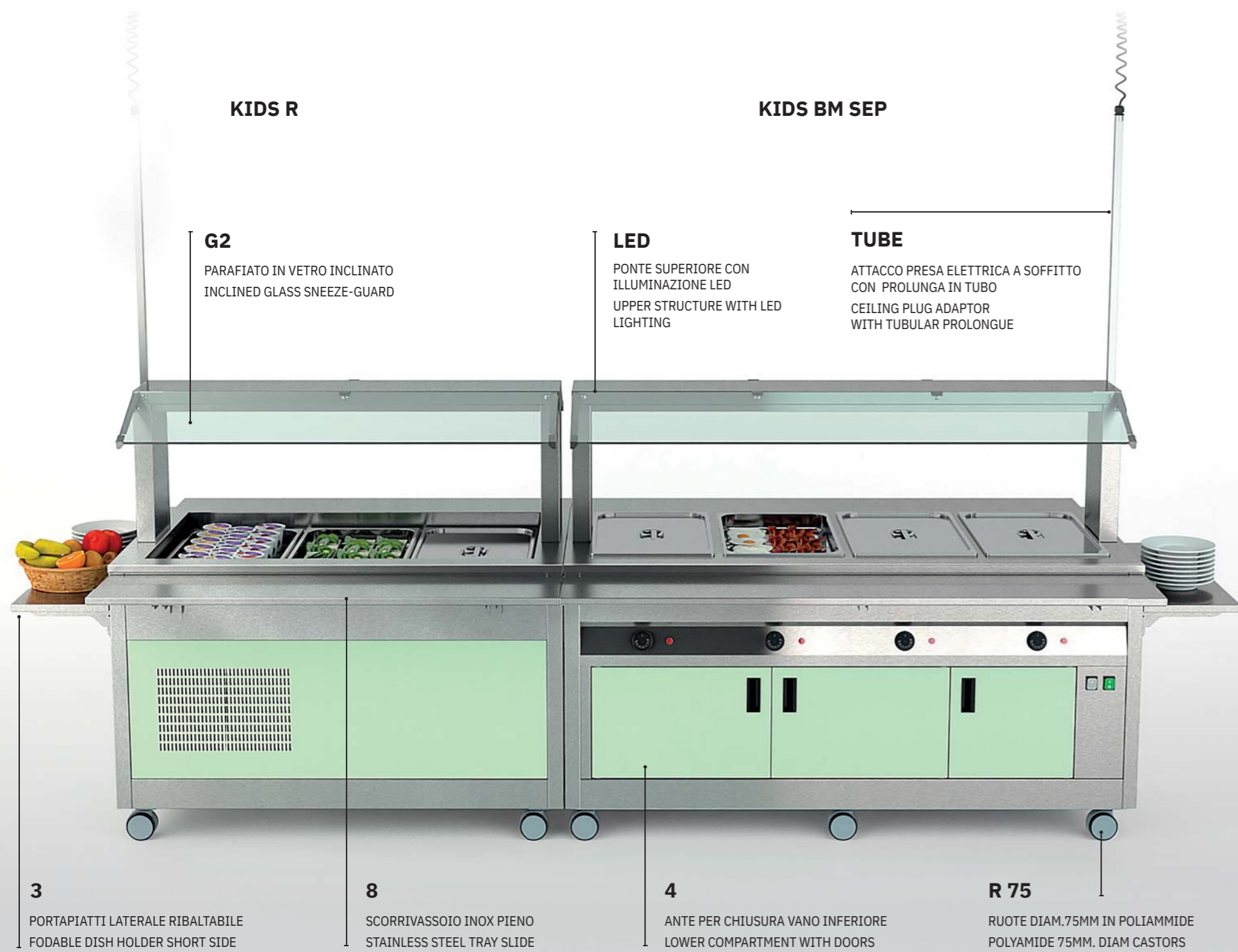

KIDS R

KIDS BM SEP

G2

PARAFIATO IN VETRO INCLINATO
INCLINED GLASS SNEEZE-GUARD

LED

PONTE SUPERIORE CON
ILLUMINAZIONE LED
UPPER STRUCTURE WITH LED
LIGHTING

TUBE

ATTACCO PRESA ELETTRICA A SOFFITTO
CON PROLUNGA IN TUBO
CEILING PLUG ADAPTOR
WITH TUBULAR PROLONGUE

3

PORTAPIATTI LATERALE RIBALTABILE
FODABLE DISH HOLDER SHORT SIDE

8

SCORRIVASSOIO INOX PIENO
STAINLESS STEEL TRAY SLIDE

4

ANTE PER CHIUSURA VANO INFERIORE
LOWER COMPARTMENT WITH DOORS

R 75

RUOTE DIAM.75MM IN POLIAMMIDE
POLYAMIDE 75MM. DIAM CASTORS

Layout - Primary school cafeteria

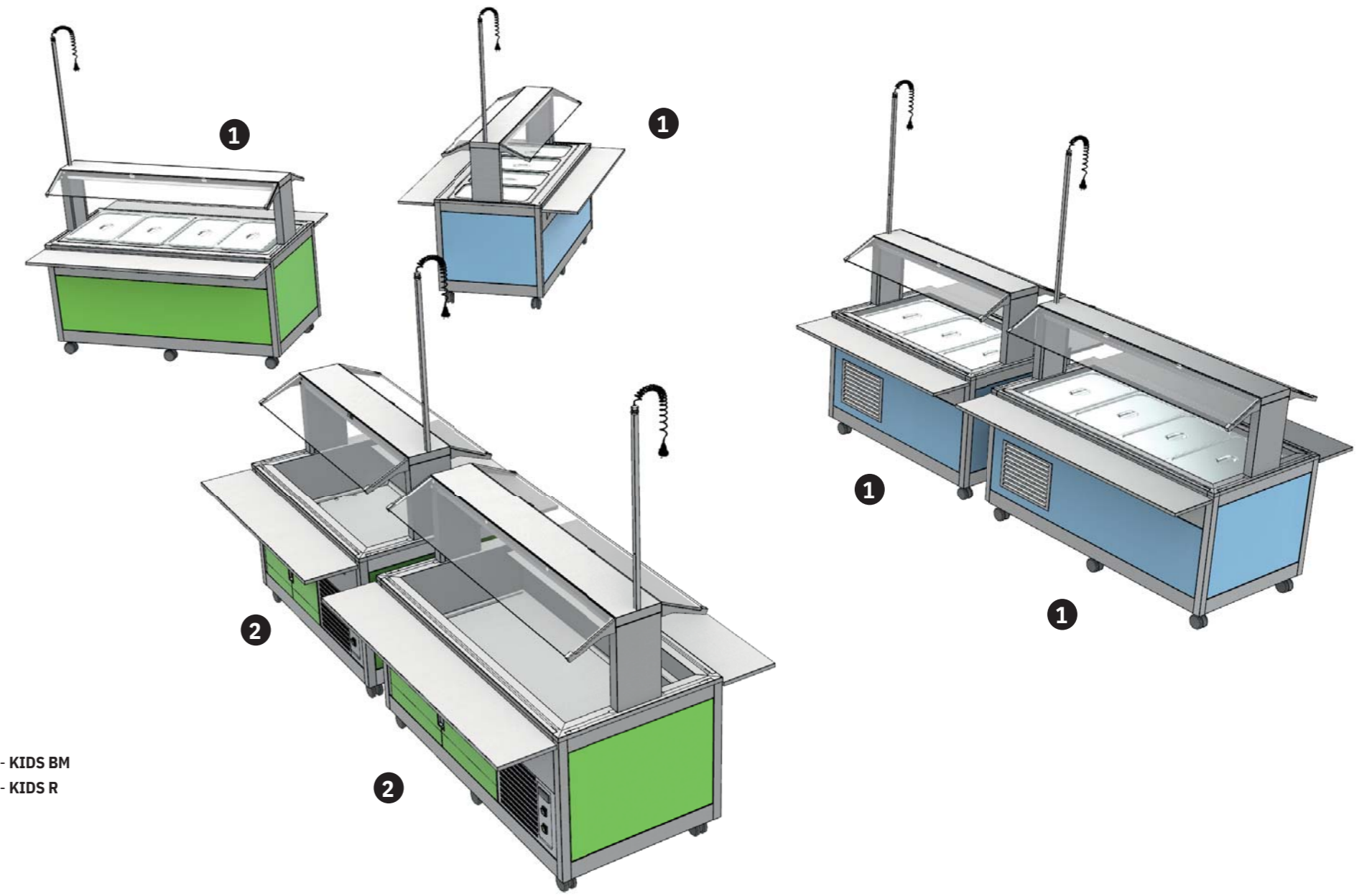

1- KIDS BM
2- KIDS R

Products Range

FOODSERVICE & CATERING

Solutions for chefs

La ricerca di nuove soluzioni e la costante innovazione su prodotti già esistenti sono le basi per garantire una gamma di articoli per la distribuzione e il mantenimento dei cibi che possa rispondere a tutte le esigenze degli operatori professionali.

Le nostre attrezzature si differenziano non solo per l'alto valore tecnologico che semplifica il lavoro degli operatori professionali, ma anche per la razionalità, la semplicità e l'ergonomia d'utilizzo, e, ultimo ma non per importanza, per l'essenzialità delle forme e la costante cura del dettaglio che Rocam pone in ogni articolo che produce.

Ogni articolo è studiato e progettato per rispettare i più alti standard igienici e l'acciaio inox utilizzato è interamente di qualità AISI 304 di origine europea.

Looking for new solutions and constant innovation on existing articles are the starting points to guarantee a range of foodservice products that can answer to each requirement of professionals.

Our equipment differs not only for the high technological value that simplifies the work of professional operators, but also for their rationality, their simplicity and ergonomics of use, and, last but not least, for their essential shape and the utmost attention to details that Rocam places in each item that manufactures.

Each item is studied and designed to comply with the highest hygienic standards and the stainless steel used is uniquely AISI 304 quality of EU origin.



COMPASS BM



COMPASS HALO



COMPASS F SEP



VULCANO



A-CARE



PULSAR

THERMOVEGA



THERMOCARE



PLEIADI R + PLEIADI T



PROFESSIONAL FOODSERVICE SOLUTION

ROCAM

Products Range

RESTAURANT SERVICE

The best service

I prodotti presentati in queste pagine sono l'eredità e le origini da cui tutto ebbe inizio e con cui Rocam ha saputo farsi conoscere sul mercato e diventare la realtà riconosciuta a livello internazionale che è oggi. Rocam negli anni ha presentato numerose linee di carrelli di servizio e mobili per la sala ristorante diventate iconiche e imitate ovunque nel mondo.

Oggi Rocam è orgogliosa di presentare ancora una volta una gamma di prodotti innovativa, originale, al passo con i tempi, ricercata nel design e attenta alle reali necessità di chi usa queste attrezzature tutti i giorni, con la consueta qualità e attenzione ai dettagli garantita da Rocam.

The products presented in these following pages are the legacy and origins from which it all began and with which Rocam has been able to make itself known on the market and become the internationally recognized reality it is today.

Over the years, Rocam has presented numerous lines of fine dining service trolleys and restaurant furniture that have become iconic and imitated all over the world. Today Rocam is proud to present once again an innovative, original range of products, up to date, with a refined design and attentive to the real needs of those who use this equipment every day, with the usual quality and attention to detail guaranteed by Rocam.



ARIANNA BOLLE



ARIANNA VINI



ARIANNA BAR



HIRA



GIUNONE REF



ARIANNA 2



ARIANNA TEA



POLAR 2 CH

Materiali e decori - Materials and decors

LEGNO LAMINATO LAMINATED WOOD

TINTE UNITE - PLAIN DECORS



LAR
ARGENTO
SILVER



LRS
ROSÉ
ROSE



LZA
ZAFFERANO
SAFRAN



LIM
LIME

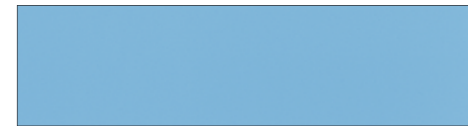

LSK
CIELO
SKY



LOC
OCEANO
OCEAN



LER
EDERA
IVY



LSV
SALVIA
SAGE

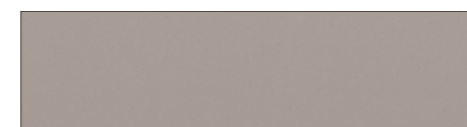

LCP
CAPPUCCINO



LTC
TERRACOTTA
CLAY



LGR
GRIGIO
GREY



LNI
NIAGARA

DECORI LEGNO - WOODEN DECORS



LBV
BIANCO VENATO
VEINED WHITE



LWS
SABBIA BIANCA
WHITE SAND



LBE
BETULLA
BIRCH



LNE
NEBBIA
FOG



LOM
OLMO
ELM



LNO
NOCE
WALNUT

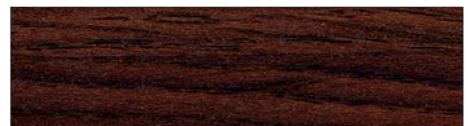

LWE
WENGÈ

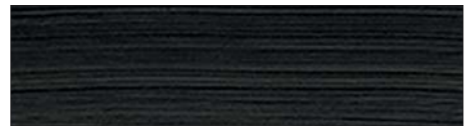

LAN
ANTRACITE
ANTHRACITE

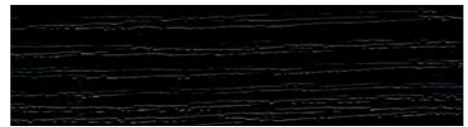

LNV
NERO VENATO
VEINED BLACK

TOP FORMICA® / LAMINATO FORMICA® / LAMINATED TOP

SOLO PER TOP ATHENA / ONLY FOR ATHENA TOP



LGB
GRANITO BIANCO
WHITE GRANITE
Formica®



LGN
GRANITO NERO
BLACK GRANITE
Formica®



LMR
MARMO GRIGIO
GREY MARBLE
Formica®



LBE
BETULLA
BIRCH



LOM
OLMO
ELM



LNO
NOCE
WALNUT

LAMIERA VERNICIATA POWDER COATED STEEL



RAL 9010
BIANCO PURO
PURE WHITE



RAL 9006
ALLUMINIO
ALUMINIUM



RAL 7037
GRIGIO
GREY



RAL 9005
NERO OPACO
MATTE BLACK

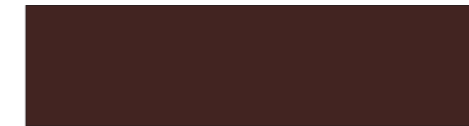

RAL 8017
CIOCCOLATO
CHOCOLATE



RAL*
*COLORE
SU RICHIESTA
COLOR ON REQUEST

ACCIAIO INOX STAINLESS STEEL



SST
ACCIAIO INOX
STAINLESS
STEEL

Le stampe dei colori dei legni, dei laminati e dei metalli potrebbero non essere totalmente fedeli agli originali.
The print of solid wood, laminated wood and metals colors may not match actual finishings exactly.



Grupo Roig

Polígono Industrial A Tomada, n 61
15940 A Pobra do Caramiñal
(A Coruña)

☎ [981 831 321](tel:981831321)

✉ gruporoig@gruporoig.es

@gruporoig